

FADK 14I4470/S35A/IO

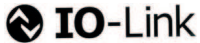

Distanz Sensor

Distance Sensor

Détecteur de distance



11014495



Baumer Electric AG · CH-8501 Frauenfeld
Phone +41 (0)52 728 1122 · Fax +41 (0)52 728 1144



Abmessungen Dimensions Dimensions

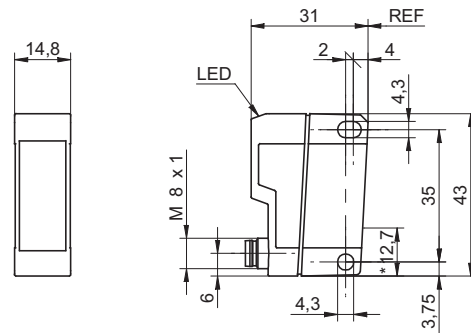

- Alle Maße in mm
- All dimensions in mm
- Toutes les dimensions en mm
- * Senderachse
- * Emitter axis
- * Axe de l'émetteur

Elektrischer Anschluss Connection diagram Schéma de raccordement

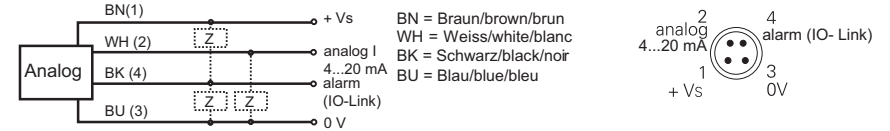

Ausgang Charakteristik Output characteristic Caractéristique de sortie

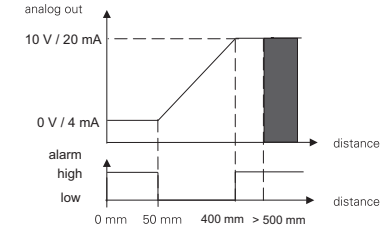

- Vor dem Anschliessen des Sensors die Anlage spannungsfrei schalten.
- Disconnect power before connecting the sensor.
- Mettre l'installation hors tension avant le raccordement du détecteur.

Canada
Baumer Inc.
CA-Burlington, ON L7M 4B9
Phone +1 (1)905 335-8444

China
Baumer (China) Co., Ltd.
CN-201612 Shanghai
Phone +86 (0)21 6768 7095

Denmark
Baumer A/S
DK-8210 Aarhus V
Phone: +45 (0)8931 7611

France
Baumer SAS
FR-74250 Fillinges
Phone +33 (0)450 392 466

Germany
Baumer GmbH
DE-61169 Friedberg
Phone +49 (0)6031 60 07 0

India
Baumer India Private Limited
IN-411058 Pune
Phone +91 20 66292400

Italy
Baumer Italia S.r.l.
IT-20090 Assago, MI
Phone +39 (0)2 45 70 60 65

Singapore
Baumer (Singapore) Pte. Ltd.
SG-339412 Singapore
Phone +65 6396 4131

Sweden
Baumer A/S
SE-56133 Huskvarna
Phone +46 (0)36 13 94 30

Switzerland
Baumer Electric AG
CH-8501 Frauenfeld
Phone +41 (0)52 728 1313

United Kingdom
Baumer Ltd.
GB-Watchfield, Swindon, SN6 8TZ
Phone +44 (0)1793 783 839

USA
Baumer Ltd.
US-Southington, CT 06489
Phone +1 (1)860 621-2121

Technische Daten

Messbereich	Auflösung (matt weisse Keramik)	Linearitätsabweichung (matt weisse Keramik)	Lichtquelle	Ansprechzeit	Analogausgang	Alarmausgang	Betriebsanzeige	Anzeige Alarm- / Verschm.	Betriebsspannungsbereich Vs (UL-Class 2)	max. Stromverbrauch	Kurzschlussfest	Verpolungsfest	Arbeitstemperaturbereich	Schutzklasse	Temperaturdrift
-------------	---------------------------------	---	-------------	--------------	---------------	--------------	-----------------	---------------------------	--	---------------------	-----------------	----------------	--------------------------	--------------	-----------------

Technical data

Measuring range	Resolution (matt white ceramic)	Linearity error (matt white ceramic)	Light source	Response time	Analog output	Alarm output	Power indicator	Soiled lens indicator	Voltage supply range Vs (UL-Class 2)	max. supply current	Short circuit protection	Reverse polarity protection	Operating temperature range	Protection class	Temperature drift
-----------------	---------------------------------	--------------------------------------	--------------	---------------	---------------	--------------	-----------------	-----------------------	--------------------------------------	---------------------	--------------------------	-----------------------------	-----------------------------	------------------	-------------------

Données techniques

Plage de mesure	Résolution (céramique blanche mate)	Déviation de linéarité (céramique blanche)	Source de lumière	Temps d'activation	Sortie analogique	Sortie d'alarme	Affichage de fonctionnement	Indication alarme / encrassement	Plage de tension Vs (UL-Class 2)	Consommation max.	Protégé contre courts-circuits	Protégé contre inversion de polarité	Température en service	Classe de protection	Dérive en température
-----------------	-------------------------------------	--	-------------------	--------------------	-------------------	-----------------	-----------------------------	----------------------------------	----------------------------------	-------------------	--------------------------------	--------------------------------------	------------------------	----------------------	-----------------------

Siehe Betriebsanleitung auf www.baumer.com See manual on www.baumer.com

Voir le manuel sur www.baumer.com



* nur Betriebsspannung / voltage supply only / plage de tension

Technische Änderungen vorbehalten Technical specifications subject to change Sous réserve de modifications techniques

Montage
Mounting
Montage

Stufen
Steps
Gradins

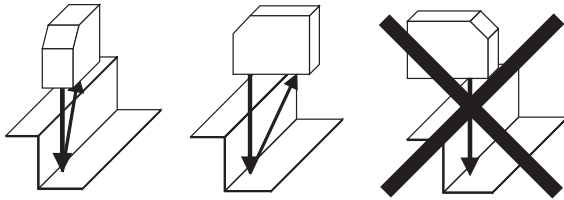

Alarm ON

Runde, glänzende Oberflächen
Round glossy surfaces
Surfaces ronds brillantes

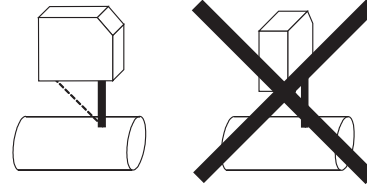

Glänzende Oberflächen
Glossy surfaces
Surfaces brillantes

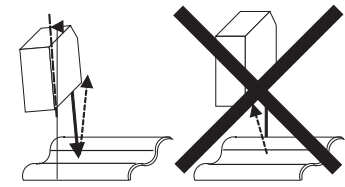

Unterschiedlich reflektierende Oberflächen
Different reflection of surfaces
Surfaces différemment réfléchissantes



Einwirkung Fremdlicht
Effect of ambient light
Influence lumière ambiante

