

ITEM 104969 CES-A-LSP-SB-104969

Description	Technical data	Accessories	Downloads
-------------	----------------	-------------	-----------



Features

- › Optimized for aluminum profile mounting
- › LED for the indication of the door position
- › M5 plug connector

Important: Actuators must be ordered separately!

Installed in aluminum profile 45 x 45 mm

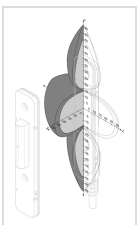

- › Typical operating distance

Approvals

Mechanical values and environment

Housing material	PA6 GF30
Weight	
Net	0,02 kg
Ambient temperature	-25 ... 70 °C
Degree of protection	IP67
Installation position	Any
Tightening torque	
Fixing screws	max.1 Nm
Connection	M5 plug connector, 3-pin
Cable length	
Maximum allowed	max.25 m
Method of operation	Inductive

Electrical connection ratings

Power supply	Via evaluation unit
LED indicator	White: valid actuator detected

Dimension drawing

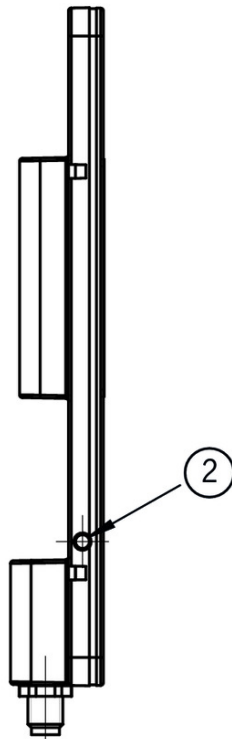
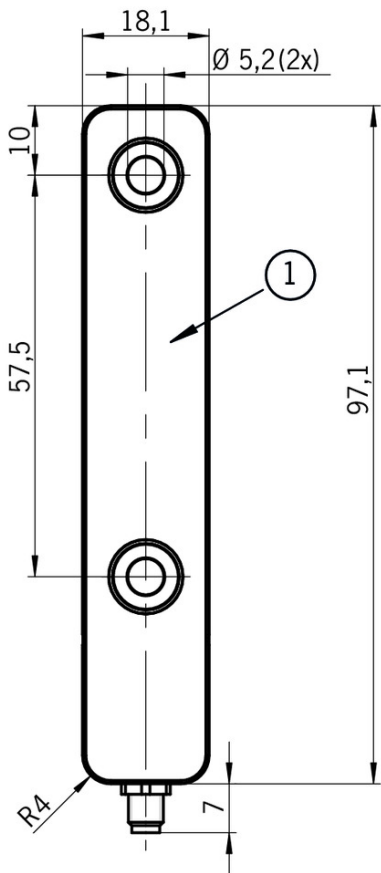
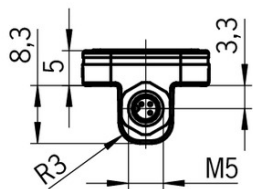

Legende

1 Active face

2 LED

Dimension drawing

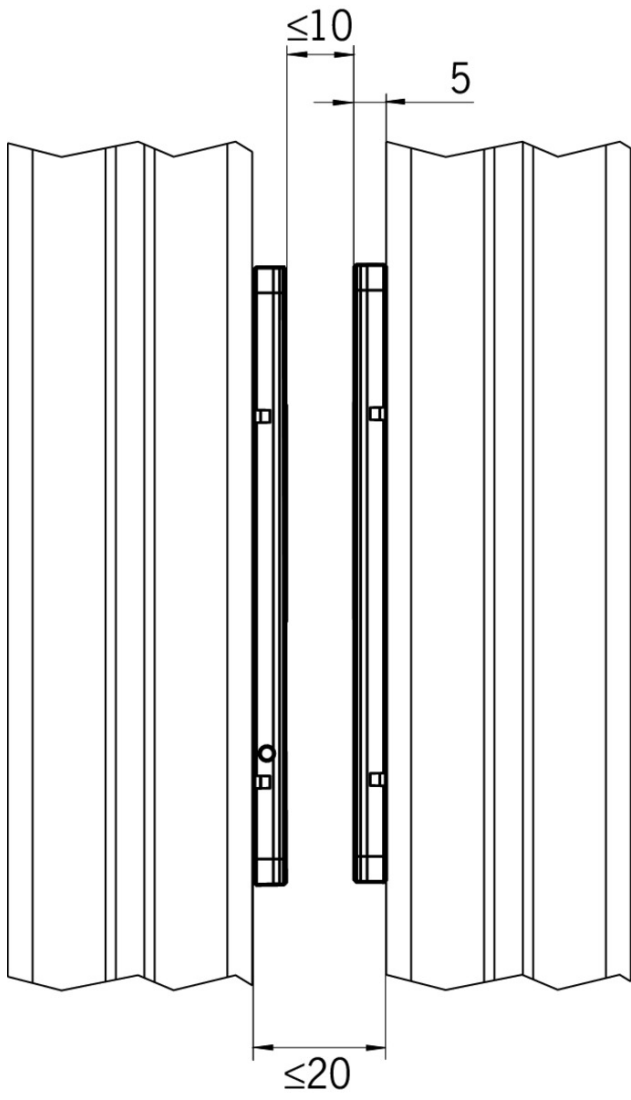

Terminal assignment

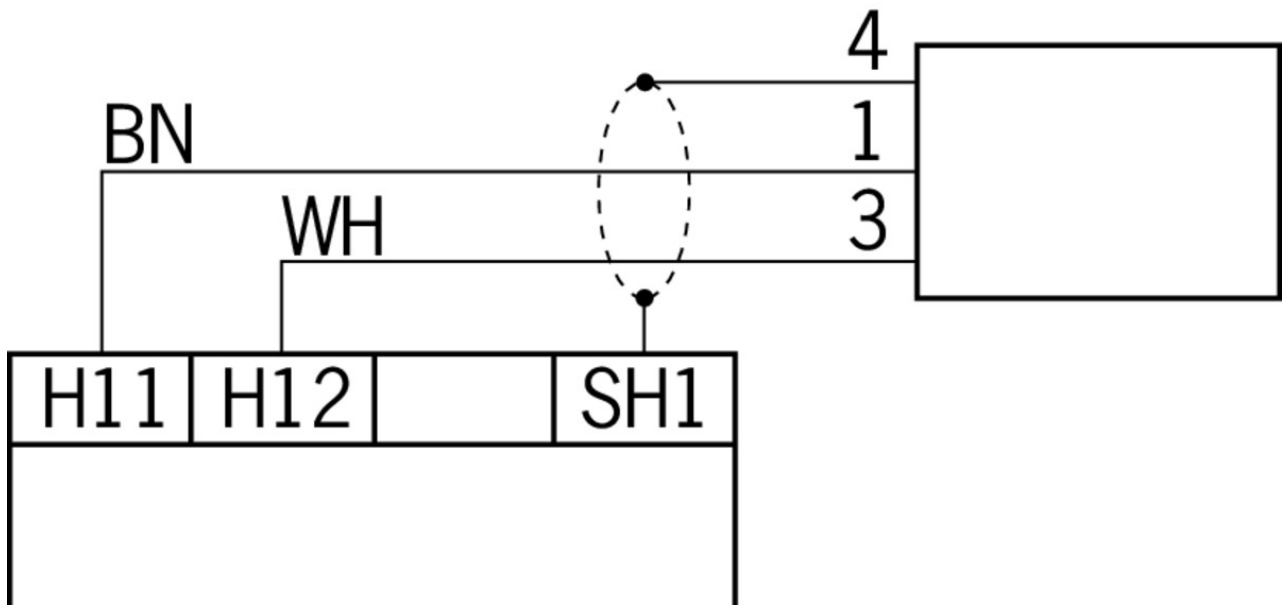

Actuator

Actuator CES-A-BSP



104970 CES-A-BSP-104970

Features

- › Optimized for aluminum profile mounting
-

Connection material

Connection cable with plug connector M5, 4-pin, 5m



105555 C-M05F04-02X014PV05,0-ES-105555

Features

- › M5 female plug, 4-pin
 - › Straight plug connector
 - › PVC cable
 - › Cable length 5 m
 - › With flying lead
-

Connection cable with plug connector M5, 4-pin, 10m



105556 C-M05F04-02X014PV10,0-ES-105556

Features

- › M5 female plug, 4-pin
 - › Straight plug connector
 - › PVC cable
 - › Cable length 10 m
 - › With flying lead
-

Connection cable with plug connector M5, 4-pin, 20m



105559 C-M05F04-02X014PV20,0-ES-105559

Features

- › M5 female plug, 4-pin
 - › Straight plug connector
 - › PVC cable
 - › Cable length 20 m
 - › With flying lead
-

Mounting accessories

Installation material for CES-A-LSP-... and CES-A-BSP



106633 MONTAGEMATERIAL 8-NUT BOSCH

Features

- › For Bosch profiles with 8 mm groove
 - › For Bosch profiles with 10 mm groove
 - › For ITEM profiles with 8 mm groove
 - › 2 screws and 2 clamping pieces each
-



106634 MONTAGEMATERIAL 10-NUT BOSCH

Features

- › For Bosch profiles with 8 mm groove
- › For Bosch profiles with 10 mm groove
- › For ITEM profiles with 8 mm groove
- › 2 screws and 2 clamping pieces each



106635 MONTAGEMATERIAL 8-NUT ITEM

Features

- › For Bosch profiles with 8 mm groove
- › For Bosch profiles with 10 mm groove
- › For ITEM profiles with 8 mm groove
- › 2 screws and 2 clamping pieces each

Instructions

▼ Návod k použití Bezkontaktní bezpečnostní systém CES-AZ-AES-... (Unicode)

	Doc. no.	Version	Language	Download
Betriebsanleitung Berührungsloses Sicherheitssystem CES-AZ-AES-... (Unicode)	2104766	10-09/17		1.8 MB
Mode d'emploi Système de sécurité sans contact CES-AZ-AES-... (Unicode)	2104766	10-09/17		1.8 MB
Manual de instrucciones Sistema de seguridad sin contacto CES-AZ-AES-... (Unicode)	2104766	10-09/17		1.8 MB
Návod k použití Bezkontaktní bezpečnostní systém CES-AZ-AES-... (Unicode)	2104766	10-09/17		1.9 MB
Operating instructions Non-contact safety system CES-AZ-AES-... (Unicode)	2104766	10-09/17		1.8 MB
Istruzioni di impiego Sistema di sicurezza senza contatto CES-AZ-AES-... (Unicode)	2104766	10-09/17		1.8 MB
使用说明书非接触式安全系统 CES-AZ-AES-... (特殊编码)	2104766	10-09/17		2.0 MB









▼ Návod k použití Bezkontaktní bezpečnostní systém CES-AZ-UES-... (Multicode)

	Doc. no.	Version	Language	Download
Betriebsanleitung Berührungsloses Sicherheitssystem CES-AZ-UES-... (Multicode)	2105274	09-09/17		1.8 MB
Mode d'emploi Système de sécurité sans contact CES-AZ-UES-... (Multicode)	2105274	09-09/17		1.8 MB
Manual de instrucciones Sistema de seguridad sin contacto CES-AZ-UES-... (Multicode)	2105274	09-09/17		1.8 MB
Návod k použití Bezkontaktní bezpečnostní systém CES-AZ-UES-... (Multicode)	2105274	09-09/17		1.9 MB
Operating instructions Non-contact safety system CES-AZ-UES-... (Multicode)	2105274	09-09/17		1.8 MB

Istruzioni di impiego Sistema di sicurezza senza contatto CES-AZ-UES-... (Multicode)	2105274	09-09/17		 1.8 MB
使用说明书非接触式安全系统 CES-AZ-UES-... (通用编码)	2105274	09-09/17		 2.0 MB







Catalogs

-  Transpondercodierte Sicherheitssysteme mit externer Auswertung Transponder-coded safety systems with external evaluation Sistemas de seguridad con codificación por transponder y evaluación externa Systèmes de sécurité à codage par transpondeur avec analyse externe

	Doc. no.	Version	Language	Download
Transpondercodierte Sicherheitssysteme mit externer Auswertung	127596	02-01/18		 3.1 MB
Systèmes de sécurité à codage par transpondeur avec analyse externe	137968	02-01/18		 3.0 MB
Sistemas de seguridad con codificación por transponder y evaluación externa	139969	02-01/18		 3.0 MB
Transponder-coded safety systems with external evaluation	127597	02-01/18		 3.0 MB

Declaration of conformity

-  EU-Konformitätserklärung

	Doc. no.	Version	Language	Download
EU-Konformitätserklärung EU declaration of conformity Declaración UE de conformidad Déclaration UE de conformité Dichiarazione di conformità	2077154	34-01/17	    	 0.5 MB

CAD data

CAD data for this item on TraceParts