

ITEM 113294 CES-A-LNN-10V-113294

Description	Technical data	Accessories	Downloads
-------------	----------------	-------------	-----------

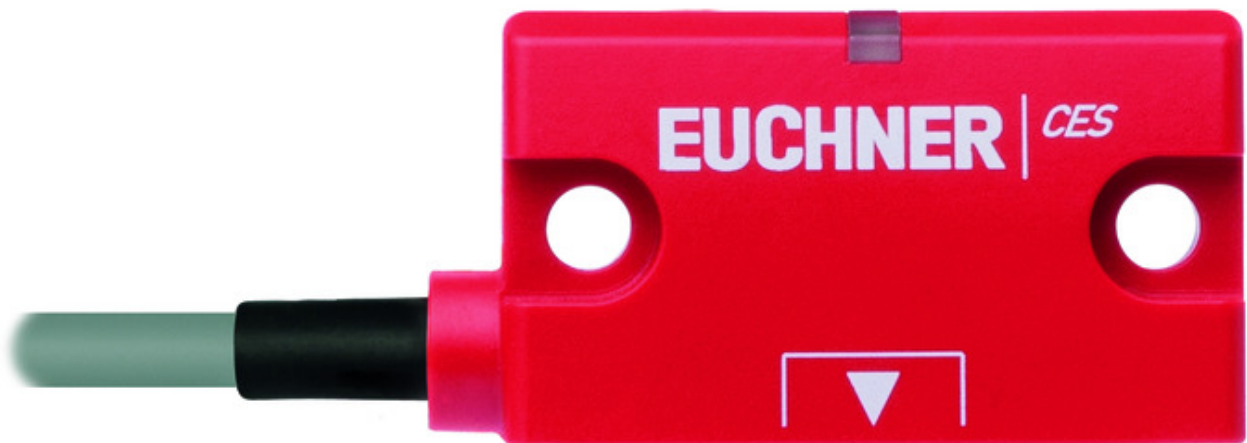

Features

- › Cube-shaped design 42 x 25 mm
- › Attachment compatible with series CES-A-LNA/LCA
- › LED for the indication of the door position
- › Hard-wired encapsulated cable, PVC
- › Cable length 10 m

Attention: The operating distance may vary depending on the background material and installation situation.

Important: Actuators must be ordered separately!

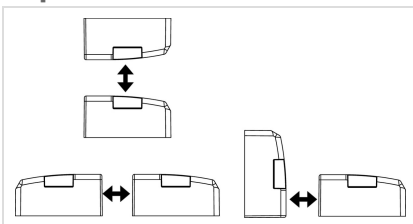

› Approach directions

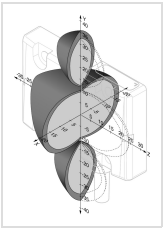

► Typical operating distance

For a side approach direction for the actuator and read head, a minimum distance of $s = 6 \text{ mm}$ must be maintained so that the operating distance of the side lobes is not entered.

Approvals



Mechanical values and environment

Housing material	Reinforced thermoplastic (PBT), fully encapsulated
Weight	Net 0,025 kg ^[1]
Ambient temperature	-25 ... 70 °C
Degree of protection	IP67
Installation position	Any
Tightening torque	Fixing screws max.1 Nm
Connection	Hard-wired encapsulated connection cable
Cable length	Maximum allowed max.25 m
Method of operation	Inductive

Electrical connection ratings

Power supply	Via evaluation unit
Connecting cable	PVC, length 10m, Ø 4.6 mm, with crimped ferrules
LED indicator	White: valid actuator detected

[1] (Without connection cable)

Dimension drawing

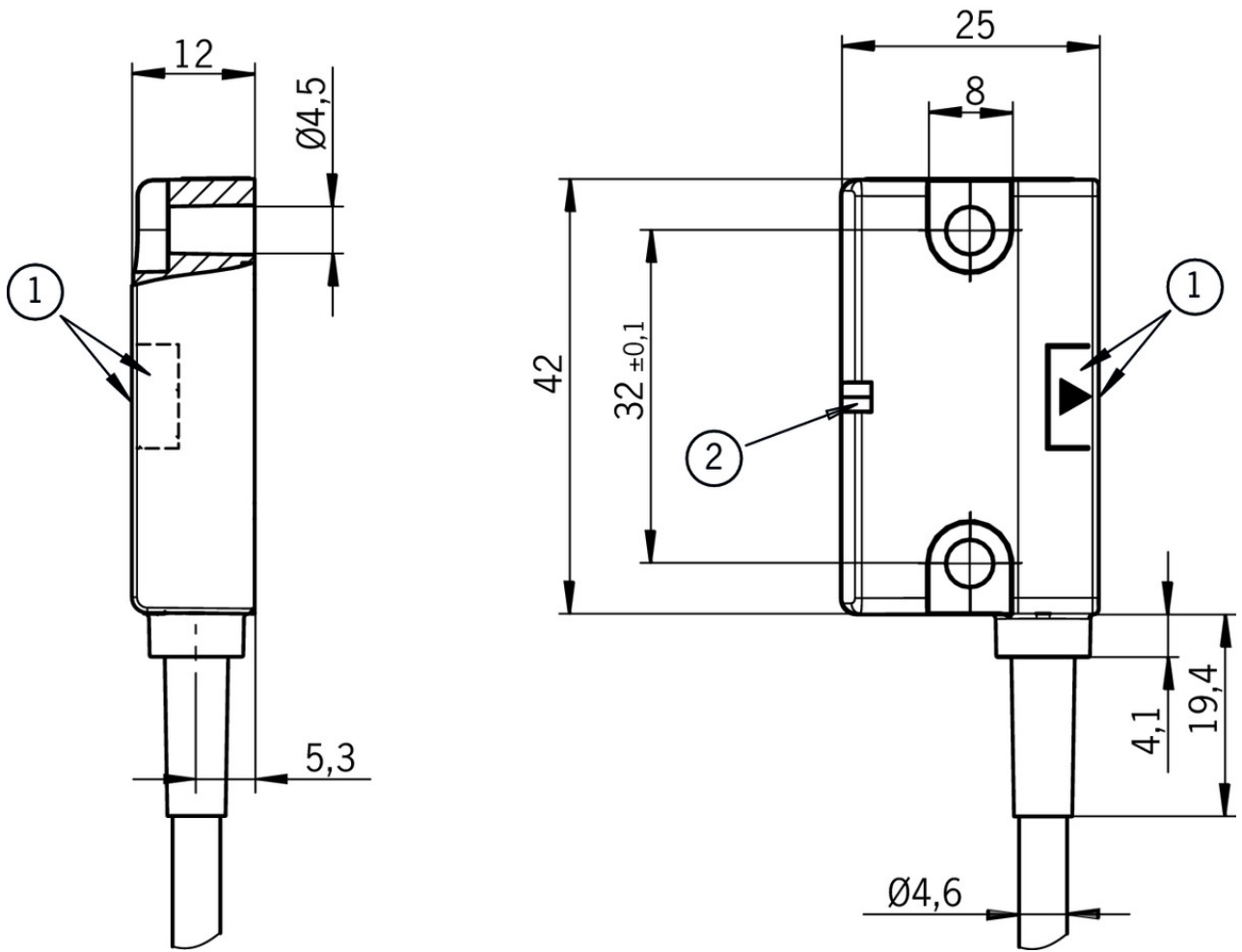

Legende

1 Active face

2 LED

Terminal assignment

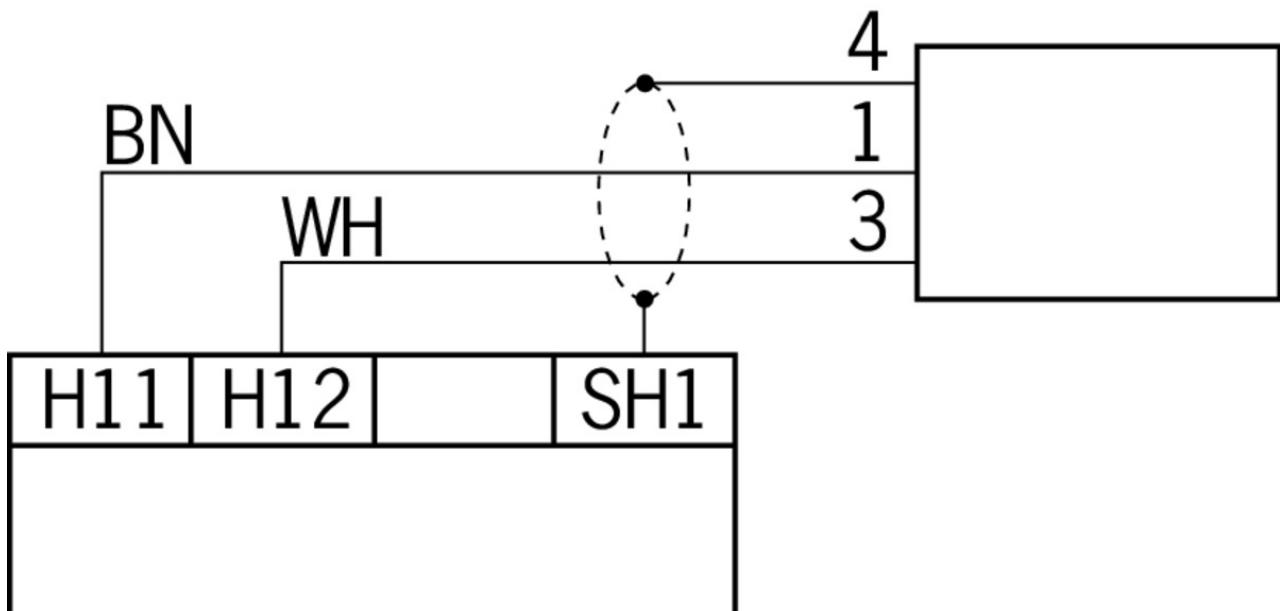

Actuator

Actuator CES-A-BBN



106600 CES-A-BBN-106600

Features

- › Cube-shaped design 42 x 25 mm
- › Attachment compatible with actuator CES-A-BBA/BCA

Actuator CES-A-BDN-06



104730 CES-A-BDN-06-104730

Features

- › Cylindrical design Ø 6 mm

Mounting accessories

Safety screws M4 x 14















071863 M4X14-CES/V20

Features

- › Safety screws M4 x 14
- › Packaging unit 20 pieces

Instructions

▼ Návod k použití Bezkontaktní bezpečnostní systém CES-AZ-AES-... (Unicode)









	Doc. no.	Version	Language	Download
Betriebsanleitung Berührungsloses Sicherheitssystem CES-AZ-AES-... (Unicode)	2104766	10-09/17		 1.8 MB
Mode d'emploi Système de sécurité sans contact CES-AZ-AES-... (Unicode)	2104766	10-09/17		 1.8 MB
Manual de instrucciones Sistema de seguridad sin contacto CES-AZ-AES-... (Unicode)	2104766	10-09/17		 1.8 MB
Návod k použití Bezkontaktní bezpečnostní systém CES-AZ-AES-... (Unicode)	2104766	10-09/17		 1.9 MB
Operating instructions Non-contact safety system CES-AZ-AES-... (Unicode)	2104766	10-09/17		 1.8 MB
Istruzioni di impiego Sistema di sicurezza senza contatto CES-AZ-AES-... (Unicode)	2104766	10-09/17		 1.8 MB
使用说明书非接触式安全系统 CES-AZ-AES-... (特殊编码)	2104766	10-09/17		 2.0 MB

▼ Návod k použití Bezkontaktní bezpečnostní systém CES-AZ-UES-... (Multicode)

	Doc. no.	Version	Language	Download
Betriebsanleitung Berührungsloses Sicherheitssystem CES-AZ-UES-... (Multicode)	2105274	09-09/17		 1.8 MB
Mode d'emploi Système de sécurité sans contact CES-AZ-UES-... (Multicode)	2105274	09-09/17		 1.8 MB
Manual de instrucciones Sistema de seguridad sin contacto CES-AZ-UES-... (Multicode)	2105274	09-09/17		 1.8 MB
Návod k použití Bezkontaktní bezpečnostní systém CES-AZ-UES-... (Multicode)	2105274	09-09/17		 1.9 MB
Operating instructions Non-contact safety system CES-AZ-UES-... (Multicode)	2105274	09-09/17		 1.8 MB
Istruzioni di impiego Sistema di sicurezza senza contatto CES-AZ-UES-... (Multicode)	2105274	09-09/17		 1.8 MB
使用说明书非接触式安全系统 CES-AZ-UES-... (通用编码)	2105274	09-09/17		 2.0 MB





Catalogs

▼ Transpondercodierte Sicherheitssysteme mit externer Auswertung Transponder-coded safety systems with external evaluation Sistemas de seguridad con codificación por transponder y evaluación externa Systèmes de sécurité à codage par transpondeur avec analyse externe

	Doc. no.	Version	Language	Download
Transpondercodierte Sicherheitssysteme mit externer Auswertung	127596	02-01/18		 3.1 MB
Systèmes de sécurité à codage par transpondeur avec analyse externe	137968	02-01/18		 3.0 MB
Sistemas de seguridad con codificación por transponder y evaluación externa	139969	02-01/18		 3.0 MB
Transponder-coded safety systems with external evaluation	127597	02-01/18		 3.0 MB

Declaration of conformity

 EU-Konformitätserklärung

	Doc. no.	Version	Language	Download
EU-Konformitätserklärung	2077154	34-01/17		 0.5 MB
EU declaration of conformity				
Declaración UE de conformidad				
Déclaration UE de conformité				
Dichiarazione di conformità			