

ITEM 090149 NZ2RS-2131

Description	Technical data	Accessories	Downloads
-------------	----------------	-------------	-----------



Features

- › Version C according to EN 50041(steel roller \varnothing 12 mm)
- › Plug connector SR11

Approach direction



- › Figure
Horizontal
Can be adjusted in 90° steps

Switching element

2131H Slow-action switching contact 3 NC \ominus + 1 NO

Approvals



Mechanical values and environment

Housing material	Anodized die-cast alloy
Weight	Net 0,3 kg
Ambient temperature	-25 ... 80 °C
Degree of protection	IP65
Mechanical life	30×10^6
Contact material	Silver alloy, gold flashed
Switching principle	Slow-action switching contact
Installation position	Any
Number of door position positively driven contacts	3
Number of NO contacts	1
Connection	1 x Plug connector SR11 [1]
Approach speed	max. 0,1 ... 20 m/min
Actuating element Plain bearing metal	Roller plunger [2]
Actuating force	15 ... 30 N

Electrical connection ratings

Rated thermal current I_{th}	4 A
Utilization category according to EN 60947-5-1	AC-15 4A 50V DC-13 4A 24V
Short circuit protection according to IEC 60269-1	(Fuse) 4A gG
Rated insulation voltage U_i	50 V
Rated impulse withstand voltage U_{imp}	1,5 kV
Switching current	Min. at DC 24V 1 mA

Reliability values acc. to EN ISO 13849-1

	Monitoring of the safety guard position
B10 _D	20×10^6

[1] 11-pin + PE

[2] Steel roller d roller = 12 mm

Dimension drawing

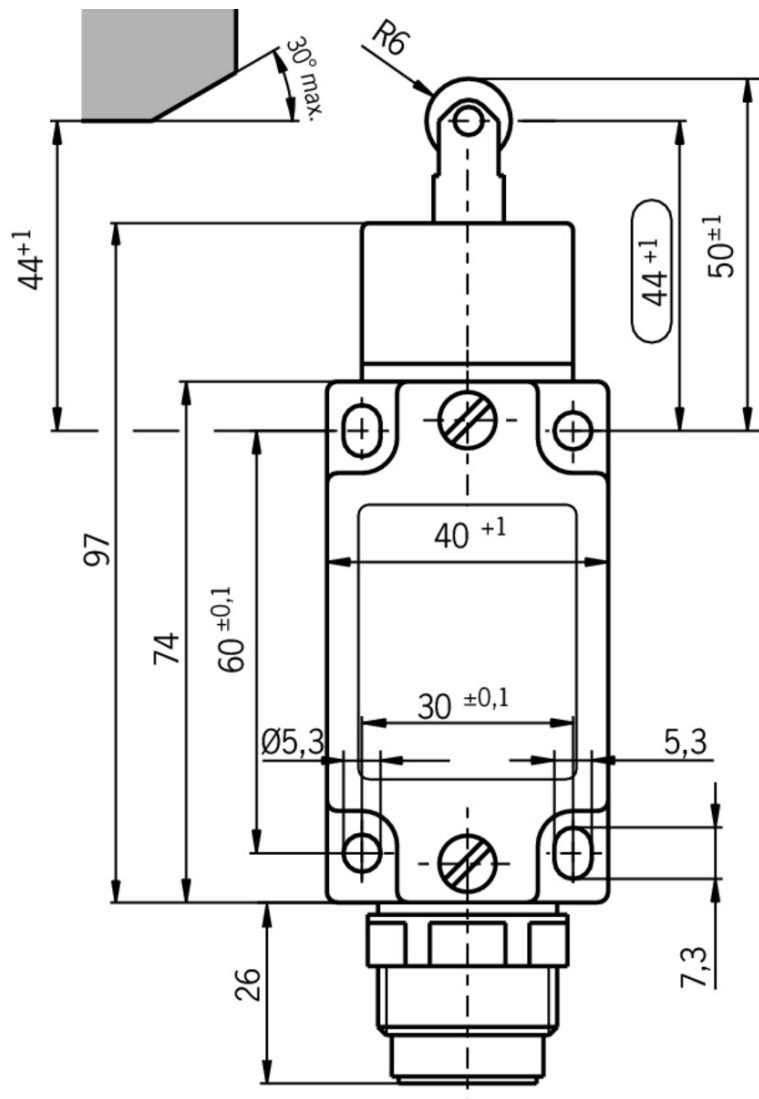

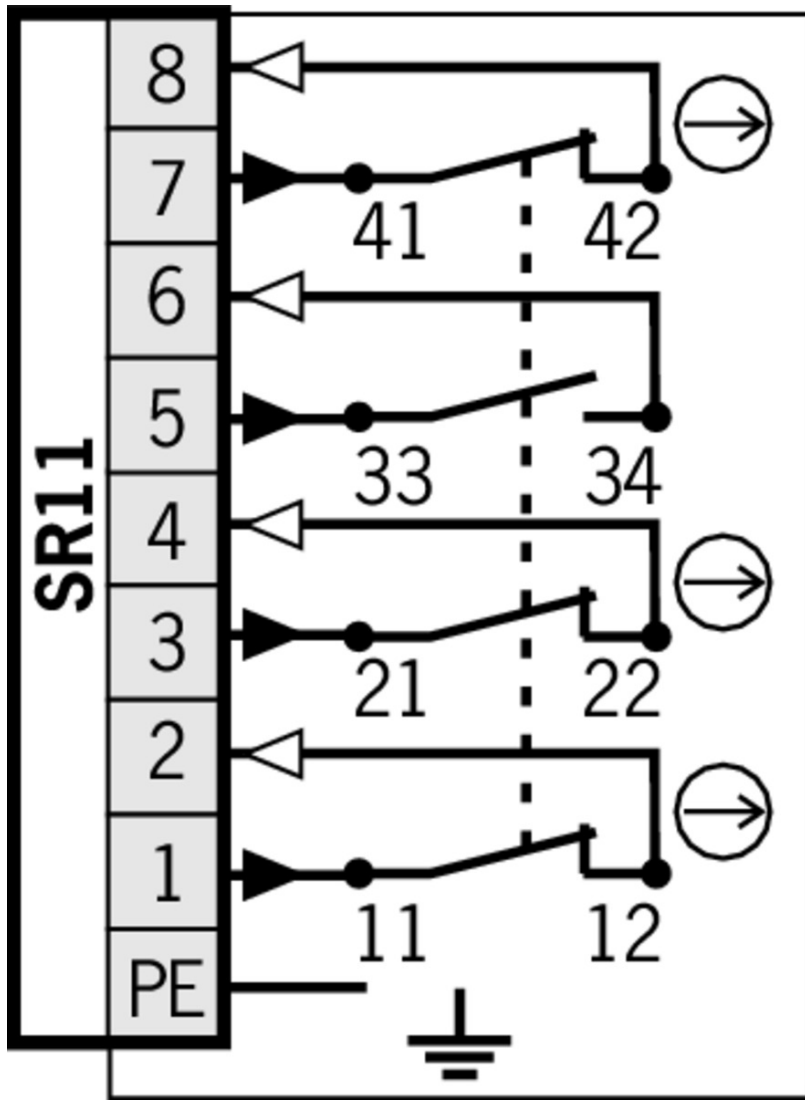



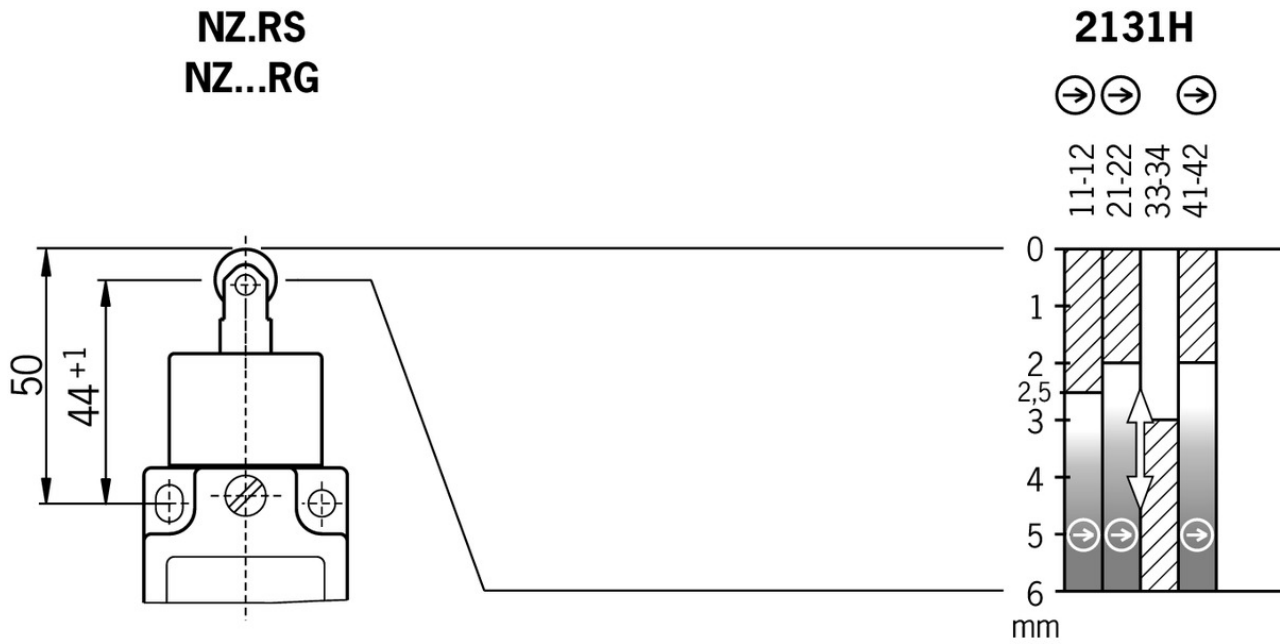

Travel diagram



Legende

-  Contacts closed
-  Contacts open
-  Contacts positively driven

Connection material

-  Plug connector SR11 for safety switches NZ and TZ

070859 SR11EF

Features

- › Crimp contacts
- › Cable optional
- › Coding shells

054773 SR11WF

Features

- › Crimp contacts
- › 90° angled optional
- › Cable optional
- › Coding shells

091296 SR11AM2-M20

Features

- › Crimp contacts
- › Cable optional
- › Coding shells

▼ Connection cable with plug connector SR11, 5m



077629 C-M26F12-12X1,00PU05,0-MA-077629

▼ Features

- › Female plug SR11, 11-pin + PE
- › Straight plug connector
- › PUR cable
- › Cable length 5 m
- › With flying lead

▼ Connection cable with plug connector SR11, 5m, angled



077635 C-M26F12-12X1,0PU05,0-MA-077635

▼ Features

- › Female plug SR11, 11-pin + PE
- › Angled plug connector
- › PUR cable
- › Cable length 5 m
- › With flying lead

▼ Connection cable with plug connector SR11, 10m



077630 C-M26F12-12X1,00PU10,0-MA-077630

▼ Features

- › Female plug SR11, 11-pin + PE
- › Straight plug connector
- › PUR cable
- › Cable length 10 m
- › With flying lead

▼ Connection cable with plug connector SR11, 10m, angled



077636 C-M26F12-12X1,0PU10,0-MA-077636

▼ Features

- › Female plug SR11, 11-pin + PE
- › Angled plug connector
- › PUR cable
- › Cable length 10 m
- › With flying lead

▼ Connection cable with plug connector SR11, 15m



077631 C-M26F12-12X1,00PU15,0-MA-077631

▼ Features

- › Female plug SR11, 11-pin + PE
 - › Straight plug connector
 - › PUR cable
 - › Cable length 15 m
 - › With flying lead
-

- ▼ Connection cable with plug connector SR11, 15m, angled



077637 C-M26F12-12X1,0PU15,0-MA-077637

▼ Features

- › Female plug SR11, 11-pin + PE
- › Angled plug connector
- › PUR cable
- › Cable length 15 m
- › With flying lead

- ▼ Connection cable with plug connector SR11, 20m



096632 C-M26F12-12X1,0PU20,0-MA-096632

▼ Features

- › Female plug SR11, 11-pin + PE
- › Straight plug connector
- › PUR cable
- › Cable length 20 m
- › With flying lead

- ▼ Connection cable with plug connector SR11, 25m



094749 C-M26F12-12X1,0PU25,0-MA-094749

▼ Features

- › Female plug SR11, 11-pin + PE
- › Straight plug connector
- › PUR cable
- › Cable length 25 m
- › With flying lead

Instructions

- ▼ Betriebsanleitung Sicherheitsschalter NZ.D.../NZ.W.../NZ.R...

	Doc. no.	Version	Language	Download
Betriebsanleitung Sicherheitsschalter NZ.D.../NZ.W.../NZ.R...	074549	10-01/17		1.8 MB
Manual de instrucciones Interruptores de seguridad NZ.D.../NZ.W.../NZ.R...				
Mode d'emploi Interrupteur de sécurité NZ.D.../NZ.W.../NZ.R...				
Istruzioni di impiego Finecorsa di sicurezza NZ.D.../NZ.W.../NZ.R...				
Operating Instructions Safety Switch NZ.D.../NZ.W.../NZ.R...				
Instrukcja obsługi Wyłącznik bezpieczeństwa NZ.D.../NZ.W.../NZ.R...	074549	10-01/17		0.4 MB

Инструкция по эксплуатации Предохранительный выключатель NZ.D.../NZ.W.../NZ.R...	074549	10-01/17		0.6 MB
Návod na prevádzku Bezpečnostný spínač NZ.D.../NZ.W.../NZ.R...	074549	10-01/17		0.4 MB

Catalogs

- Sicherheitsschalter mit Metallgehäuse Safety Switches with Metal Housing Bezpečnostní spínače s kovovým pouzdrém Interrupteurs de sécurité avec boîtier métallique 金属壳体 的安全开关 Interruptores de seguridad con carcasa metálica

	Doc. no.	Version	Language	Download
Sicherheitsschalter mit Metallgehäuse	100319	11-03/18		7.9 MB
Interrupteurs de sécurité avec boîtier métallique	100676	11-03/18		7.9 MB
Interruptores de seguridad con carcasa metálica	104856	11-03/18		14.0 MB
Safety Switches with Metal Housing	100369	11-03/18		7.9 MB
Bezpečnostní spínače s kovovým pouzdrém	121650	11-03/18		7.9 MB
金属壳体 的安全开关	102453	11-03/18		8.2 MB

Declaration of conformity

- EU prohlášení o shodě

	Doc. no.	Version	Language	Download
EU-Konformitätserklärung Declaración UE de conformidad Déclaration UE de conformité Dichiarazione di conformità EU declaration of conformity	2077153	25-02/17	 	0.3 MB
EU prohlášení o shodě EU-overensstemmelseserklæring Δήλωση συμμόρφωσης της ΕΕ EU-vaatimustenmukaisuusvakuutus EU-típusbizonyítvány EU-conformiteitsverklaring Deklaracja zgodności UE Declaração de Conformidade UE Declarația de conformitate UE EÚ vyhlásenie o zhode	2077153	25-02/17	 	0.5 MB

CAD data

CAD data for this item on TraceParts