

ITEM 113893 ES-XW1E-BV404MFR

Description	Technical data	Accessories	Downloads
-------------	----------------	-------------	-----------



**Features**

- › Button head red 40 mm ø
- › Contact block monitoring
- › Reset by pulling or turning

**Switching element**

- › 4 NC ⊕

**Approvals**



**Mechanical values and environment**

Material	Button	Fiber glass reinforced thermoplastic
----------	--------	--------------------------------------

Housing	Polycarbonate
Ambient temperature	-25 ... 60 °C
Degree of protection	IP20
Mechanical life	0,25 x 10 <sup>6</sup>
Contact material	Silver alloy, gold flashed
Mounting method	IEC 947-5-1 D22
Number of positively driven contacts	4
Connection	Screw terminal

### Electrical connection ratings

Rated thermal current I <sub>th</sub>	1 A
Utilization category according to EN 60947-5-1	
AC-15	1.5 A 250 V
DC-13	1A 30V
Rated insulation voltage U <sub>i</sub>	250 V
Switching current	
Min. at 24V	10 mA

### Miscellaneous

Additional feature	
	Button head Ø 40 mm
	Reset by pulling or turning
	Contact block monitoring
Color	
Actuating button	Red
Bottom part	Yellow

### Reliability values acc. to EN ISO 13849-1

B10 <sub>D</sub>	0,1 x 10 <sup>6</sup>
------------------	-----------------------

**Dimension drawing**

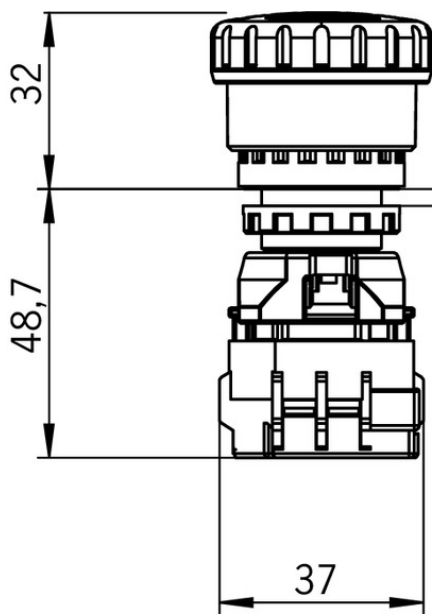

0,5 ... 3,7  
Schalttafelstärke  
Panel thickness

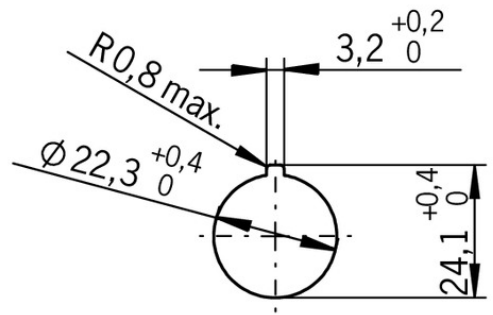
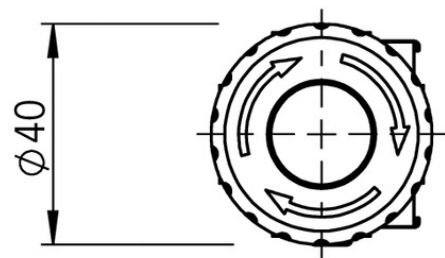
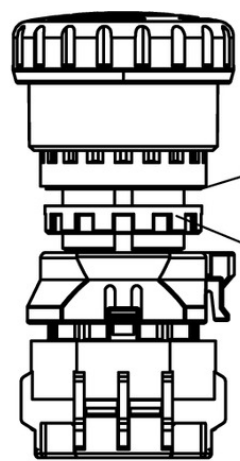

Schalttafel-ausschnitt  
Panel cut-out

## Switching functions

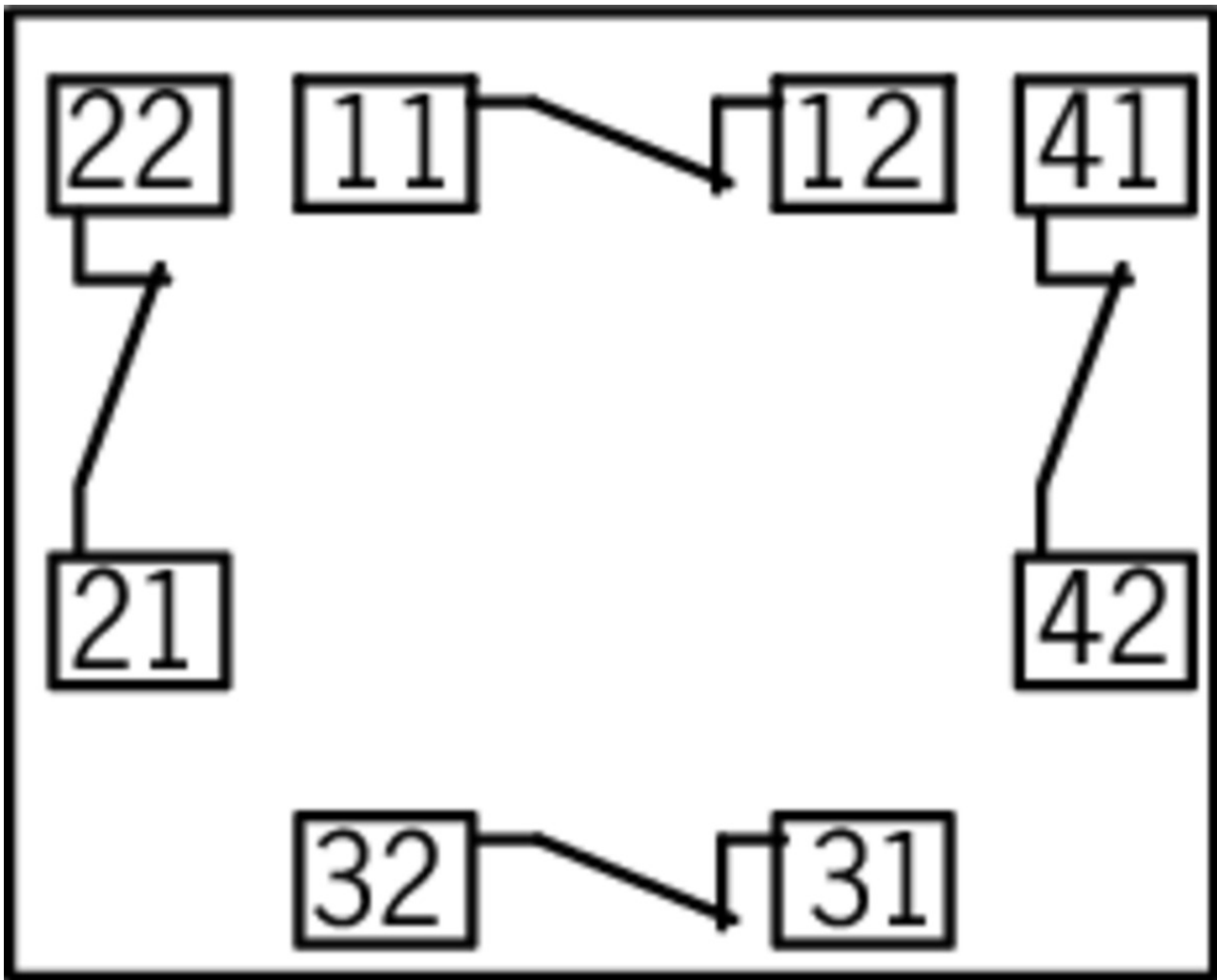

## Mounting accessories

### ☑ Key for emergency stop ES-XW

**106337** ES-MW9Z-T1

#### ☑ Features

- › Key for fastening the ring screw on ES-XW... devices

### ☑ Sign for emergency stop ES-XW



**106340** ES-HWAV-27

#### ☑ Features

- › Emergency stop label for 40 mm buttons on ES-XW devices with text "Emergency Stop"

### ☑ Sign for emergency stop ES-XA





**106342** ES-HAAV-27

#### ☑ Features

- › Key for fastening the ring screw on ES-XW... devices









## Instructions

### ▼ Betriebsanleitung Not-Aus-Schalter ES-XW/XN

	Doc. no.	Version	Language	Download
Betriebsanleitung Not-Aus-Schalter ES-XW/XN Operating Instructions Emergency Stop Switch ES-XW/XN	2105026	11-06/17	 	 1.3 MB







## Catalogs

### ▼ Not-Halt-Geräte/Seilzugschalter Emergency Stop Devices/Rope Pull Switches Dispositifs d'arrêt d'urgence/interrupteurs à câble Dispositivos de parada de emergencia / Interruptores de accionamiento por cable

	Doc. no.	Version	Language	Download
Not-Halt-Geräte/Seilzugschalter	106210	06-06/16		 1.9 MB
Dispositifs d'arrêt d'urgence/interrupteurs à câble	116529	06-06/16		 1.9 MB
Dispositivos de parada de emergencia / Interruptores de accionamiento por cable	116530	06-06/16		 1.9 MB
Emergency Stop Devices/Rope Pull Switches	116448	06-06/16		 1.9 MB

## Declaration of conformity

### ▼ EU-Konformitätserklärung

	Doc. no.	Version	Language	Download
EU-Konformitätserklärung Declaración UE de conformidad Déclaration UE de conformité Dichiarazione di conformità EU declaration of conformity	2105755	08-03/17	    	 0.2 MB