

## ITEM 077859 EKS-A-K1RDWT32-EU

Description	Technical data	Accessories	Downloads
-------------	----------------	-------------	-----------



### Features

- › Memory 116 bytes E<sup>2</sup>PROM (programmable) plus 8 bytes ROM (serial number)

### Special features

- › The Electronic-Key contains a unique 8-byte serial number. This number is written by laser during the Electronic-Key production process and is stored absolutely indestructibly. The serial number is used for secure distinction of every single Electronic-Key.

### Approvals



### Mechanical values and environment

Housing material	ABS, PC red
Ambient temperature	-20 ... 60 °C
Degree of protection	IP67







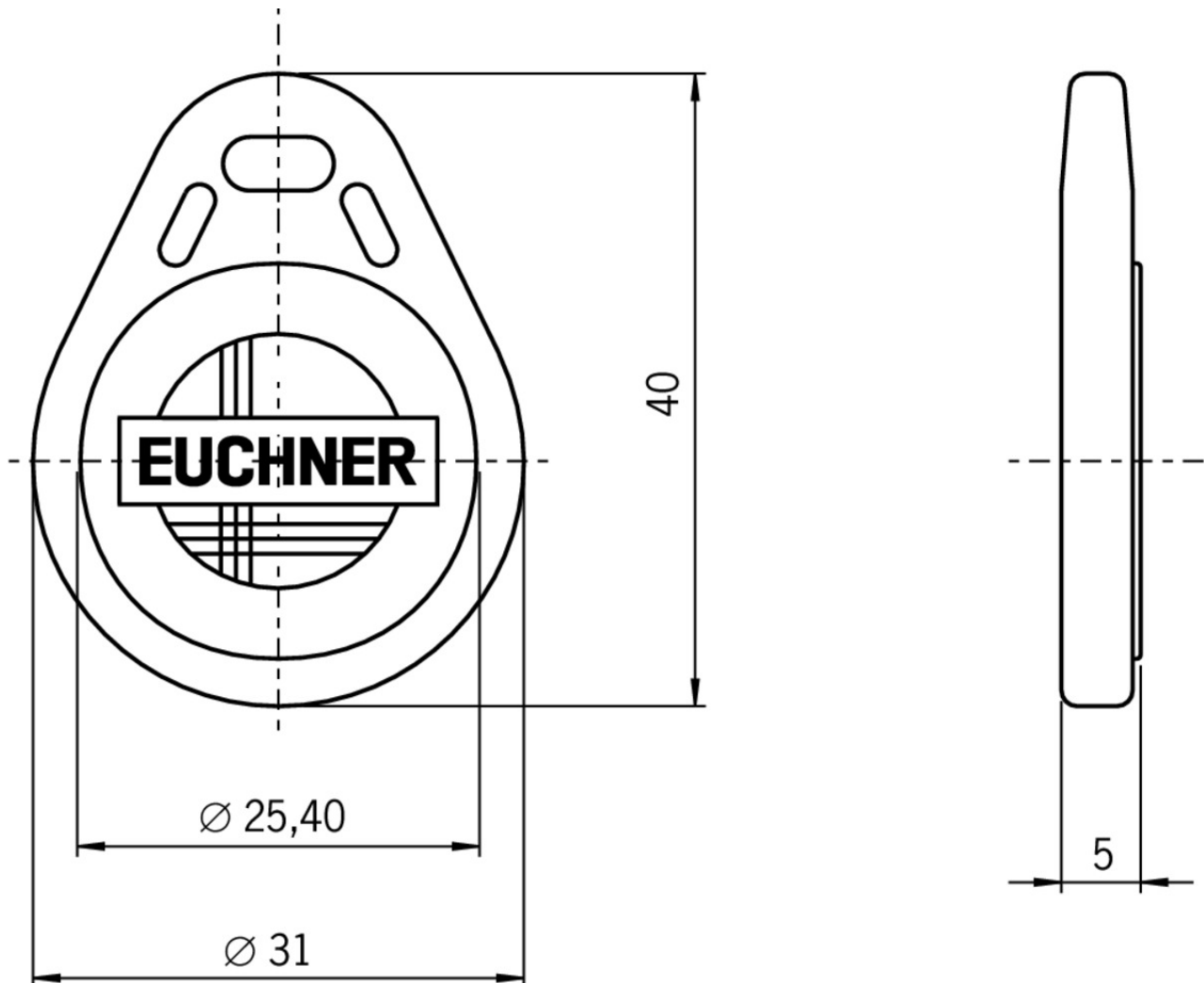

### Electrical connection ratings

Power supply	inductive via Electronic-Key adapter
Length of serial number	8 B Serial number read only
Number of read cycles	max.unbegrenzt
Number of write cycles	max.100000
Storage capacity	116 B Read / write
Data retention time	At +55°Cmax.10 y

### Dimension drawing



✓ Electronic-Key-System EKS Electronic-Key-System EKS Electronic-Key-System EKS Electronic-Key-System EKS

	<b>Doc. no.</b>	<b>Version</b>	<b>Language</b>	<b>Download</b>
Electronic-Key-System EKS	086808	14-04/17		 3.2 MB
Electronic-Key-System EKS	092953	14-04/17		 3.2 MB
Electronic-Key-System EKS	114432	14-04/17		 3.2 MB
Electronic-Key-System EKS	086809	14-04/17		 3.2 MB

**CAD data**

CAD data for this item on TraceParts