

ITEM 083900 RIEGEL NZ/TZ-ACF

Description	Technical data	Accessories	Downloads
-------------	----------------	-------------	-----------



Features

- › Steel bolt
- › For doors hinged on the right or left
- › Lever for escape release from the danger area
- › Detent knob in open position
- › Can be locked in open position with padlocks
- › Bolt for two safety switches
- › Actuator included

Advantages

- › Robust construction
- › Easily fitted to standard aluminum profiles and machine covers by screw connection
- › Distinctive yellow color for easy recognition
- › No additional door handle necessary

Special features

- › One bolt for 2 safety switches (NZ and TZ with guard locking)
- › › A higher safety category according to EN ISO 13849-1 (e.g. category 4)

is achieved

- › Bolt with detent mechanism
- › The bolt latches in open position to prevent unintentional closing of the bolt

Mechanical values and environment

Material		
	Handle	Plastic
	Guide strips	Plastic
	Base plate	Galvanized steel
	Switch bracket	Steel powder-coated
Weight		
	Net	2,5 kg
Escape release		Yes
Number of safety switches that can be fitted		2

Miscellaneous

Detent mechanism		
	Open position	Bolt detent mechanism

Dimension drawing

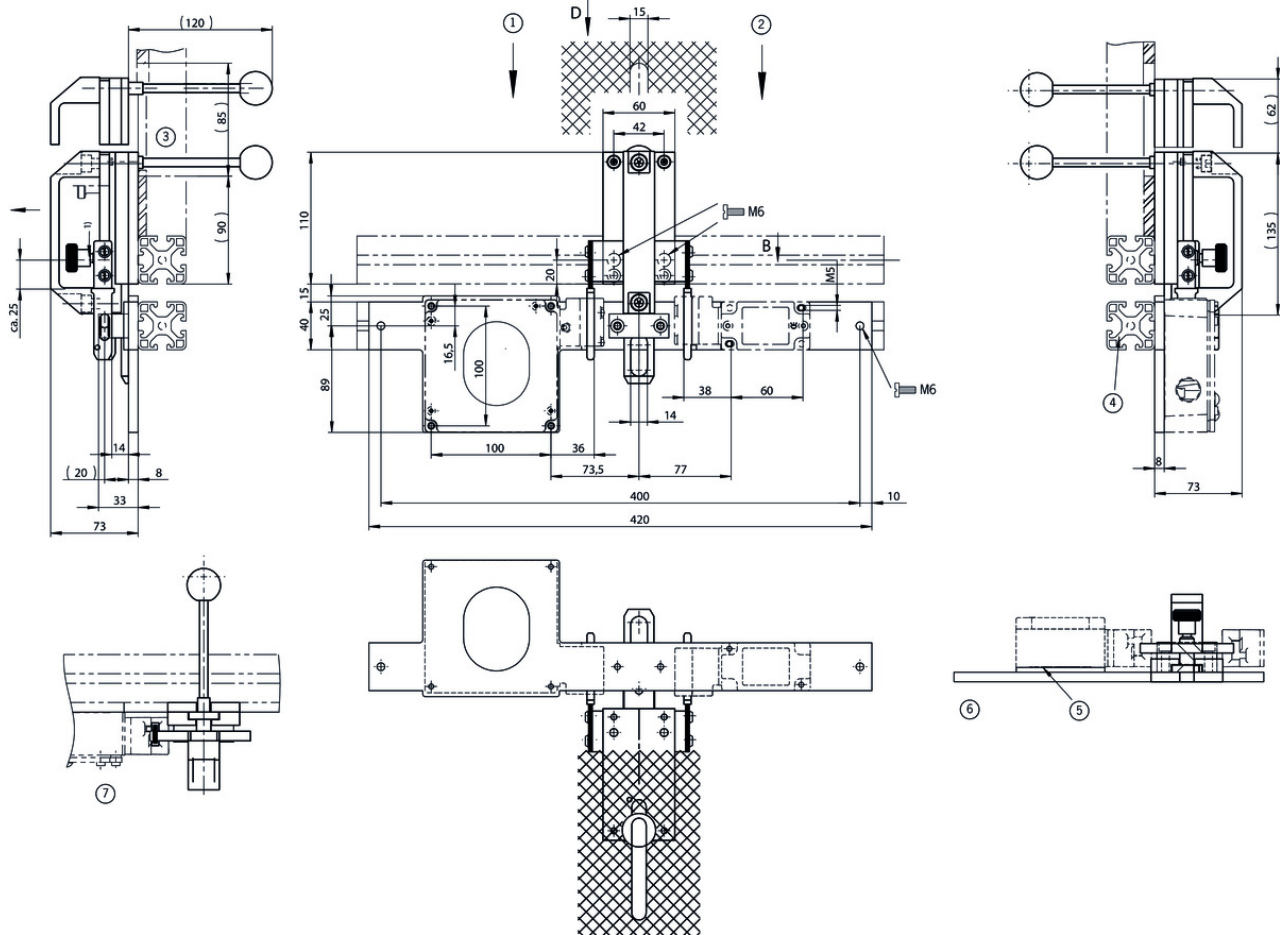

Legende

- 1 Safety switch TZ approach direction C
 - 2 Safety switch NZ.VZ approach direction A
 - 3 Door hinged on the left
 - 4 Safety guard frame (40x40)
 - 5 Spacer plate NZ
 - 6 "Safety switch and tongue receptacle can also be fastened to the rear of the switch bracket."
 - 7 View D
- 1) Bolt with detent mechanism. Engages in open position. (Prevents unintentional closing of the bolt) Unlocked by pulling the detent knob upward.

Spare parts

- ✓ Replacement handle for EUCHNER bolts















093500 RIEGELGRIFF/V5

- ✓ Features

- › Material: plastic, reinforced polypropylene (PP)
- › Color: black, mat
- › Temperature resistance up to 100 °C
- › Packaging unit 5 pieces

Catalogs

- Sicherheitsschalter mit Metallgehäuse Safety Switches with Metal Housing Bezpečnostní spínače s kovovým pouzdem Interrupteurs de sécurité avec boîtier métallique 金属壳体 的安全开关 Interruptores de seguridad con carcasa metálica

	Doc. no.	Version	Language	Download
Sicherheitsschalter mit Metallgehäuse	100319	11-03/18		 7.9 MB
Interrupteurs de sécurité avec boîtier métallique	100676	11-03/18		 7.9 MB
Interruptores de seguridad con carcasa metálica	104856	11-03/18		 14.0 MB
Safety Switches with Metal Housing	100369	11-03/18		 7.9 MB
Bezpečnostní spínače s kovovým pouzdem	121650	11-03/18		 7.9 MB
金属壳体 的安全开关	102453	11-03/18		 8.2 MB

CAD data

CAD data for this item on TraceParts