

ITEM 084592 CMS-M-AC

Description	Technical data	Accessories	Downloads
-------------	----------------	-------------	-----------



Features

- › Cube-shaped version 88 x 25 mm

Approvals



Mechanical values and environment

Design	A
Housing material	PPS
Weight	
	Net 0,032 kg [1]
Ambient temperature	-20 ... 60 °C
Degree of protection	IP67
Installation position	Any, pay attention to marking

Tightening torque	0,4 ... 0,5 Nm
Method of operation	Magnetic

Miscellaneous

in compliance with	EN ISO 13849-1:2015; EN 50178:1997; EN 60204-1:2006/A1:2009; EN ISO 14119:2013; EN 61000-6-2:2005; EN 61000-6-3:2007/A1:2011; EN 60947-5-3:2013
--------------------	---

[1] Weight with screw



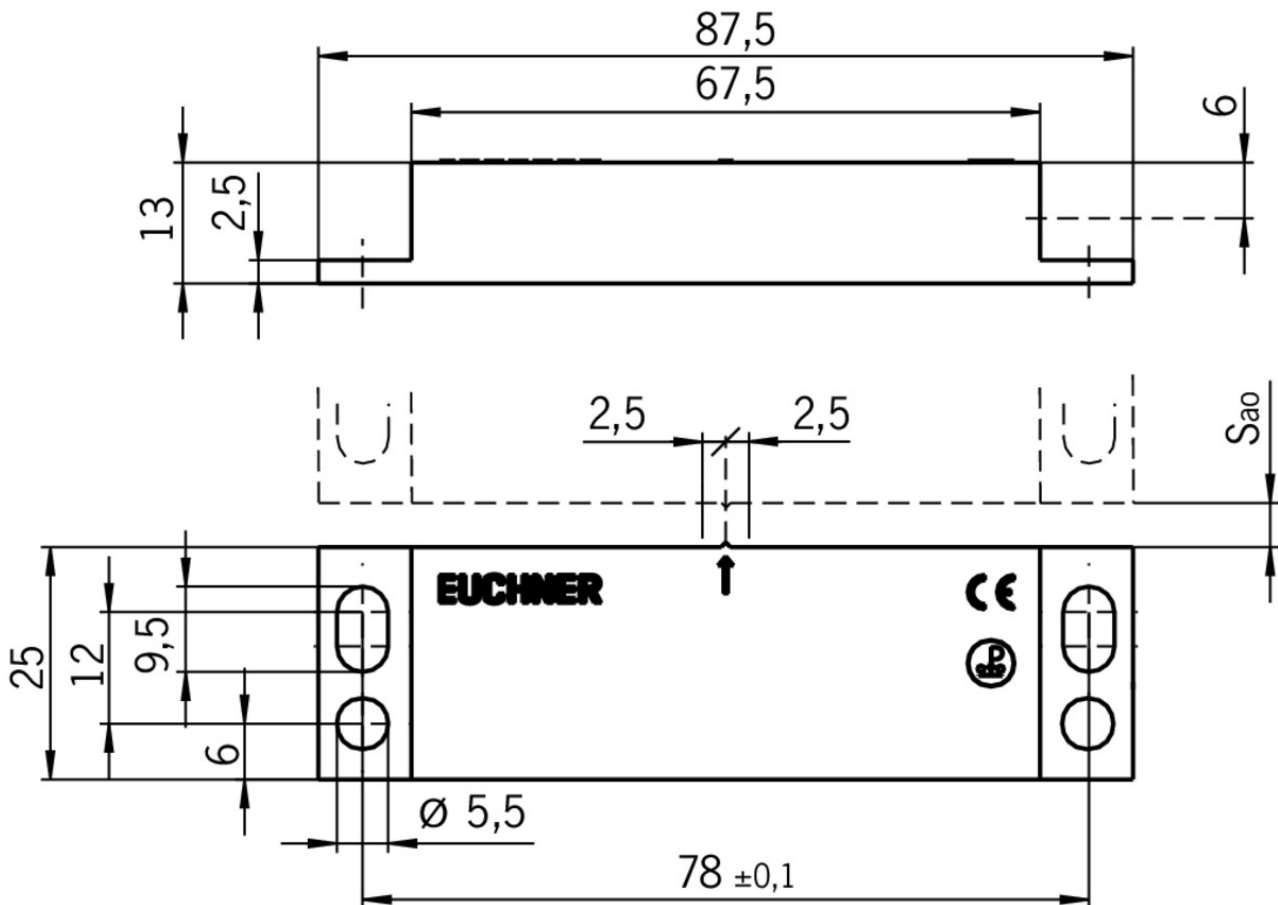







Dimension drawing



Catalogs

- [Sicherheitsschalter mit AS-Interface](#)
[Safety Switches with AS-Interface](#)
[Interrupteurs de sécurité avec AS-Interface](#)

	Doc. no.	Version	Language	Download
Sicherheitsschalter mit AS-Interface	092164	11-04/17		2.3 MB

Interrupteurs de sécurité avec AS-Interface	112564	11-04/17		 2.3 MB
Safety Switches with AS-Interface	092332	11-04/17		 2.3 MB
<input checked="" type="checkbox"/> Magnetisch codierte Sicherheitsschalter CMS Système de sécurité sans contact CMS Magnetically Coded Safety Switches CMS				
	Doc. no.	Version	Language	Download
Magnetisch codierte Sicherheitsschalter CMS	086823	09-02/18		 2.3 MB
Système de sécurité sans contact CMS	090606	09-02/18		 2.3 MB
Magnetically Coded Safety Switches CMS	086824	09-02/18		 2.3 MB

CAD data

CAD data for this item on TraceParts