

## ITEM 096390 RIEGEL S-AF

Description	Technical data	Accessories	Downloads
-------------	----------------	-------------	-----------



### Features

- › Steel bolt
- › Lever for escape release from the danger area
- › For doors hinged on the right
- › Detent knob in open position
- › Can be locked in open position with padlocks
- › Actuator included

### Advantages

- › Robust construction
- › Easily fitted to standard aluminum profiles and machine covers by screw connection
- › Distinctive yellow color for easy recognition
- › No additional door handle necessary

### Special features

- › Bolt with detent mechanism: The bolt latches in open position to prevent unintentional closing of the bolt

## Notes

- › The bolts are only suitable for series **STP.../STA.../SGA.../SGP...**
- › Order safety switch separately

## Mechanical values and environment

Material		
	Handle	Plastic
	Guide strips	Plastic
	Base plate	Galvanized steel
	Switch bracket	Steel powder-coated
Weight		
	Net	2 kg
Escape release		Yes
Number of safety switches that can be fitted		1

## Miscellaneous

Detent mechanism		
	Open position	Bolt detent mechanism

## Dimension drawing

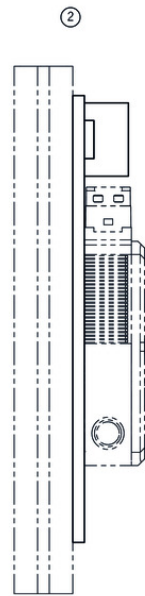
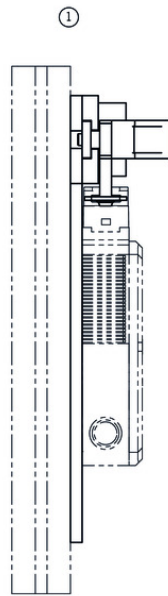
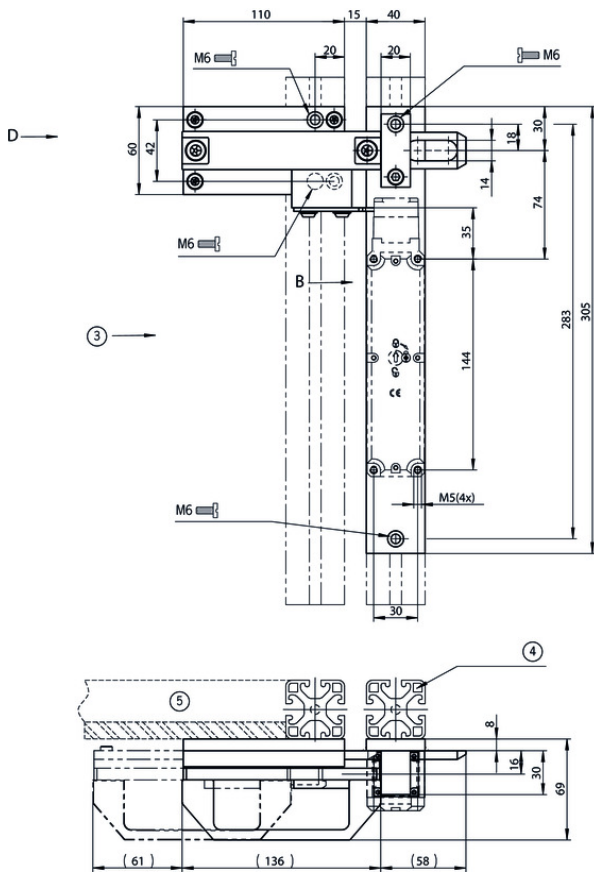

## Legende

- 1 View D
- 2 View B
- 3 Safety switch STP, STA, SGP, SGA approach direction C
- 4 Safety guard frame (40x40)
- 5 Door hinged on the left
- 6 Attention! Bolt must not be used in conjunction with an escape release.

## Spare parts

- ✓ Replacement handle for EUCHNER bolts















### 093500 RIEGELGRIFF/V5

#### ✓ Features













- › Material: plastic, reinforced polypropylene (PP)
- › Color: black, mat
- › Temperature resistance up to 100 °C
- › Packaging unit 5 pieces

## Catalogs

- ▼ Bezpečnostní spínače s plastovým pouzdrém Sicherheitsschalter mit Kunststoffgehäuse Safety Switches with Plastic Housing Interruptores de seguridad con carcasa plástica Interrupteurs de sécurité avec boîtier plastique 塑料壳体 的安全开关

	Doc. no.	Version	Language	Download
Sicherheitsschalter mit Kunststoffgehäuse	096955	11-03/18		 6.6 MB
Interrupteurs de sécurité avec boîtier plastique	100677	11-03/18		 6.6 MB
Interruptores de seguridad con carcasa plástica	104855	11-03/18		 6.6 MB
Bezpečnostní spínače s plastovým pouzdrém	121649	11-03/18		 6.6 MB
Safety Switches with Plastic Housing	096956	11-03/18		 6.6 MB
塑料壳体 的安全开关	116243	11-03/18		 6.2 MB

- ▼ Sicherheitsschalter mit Metallgehäuse Safety Switches with Metal Housing Bezpečnostní spínače s kovovým pouzdrém Interrupteurs de sécurité avec boîtier métallique 金属壳体 的安全开关 Interruptores de seguridad con carcasa metálica

	Doc. no.	Version	Language	Download
Sicherheitsschalter mit Metallgehäuse	100319	11-03/18		 7.9 MB
Interrupteurs de sécurité avec boîtier métallique	100676	11-03/18		 7.9 MB
Interruptores de seguridad con carcasa metálica	104856	11-03/18		 14.0 MB
Safety Switches with Metal Housing	100369	11-03/18		 7.9 MB
Bezpečnostní spínače s kovovým pouzdrém	121650	11-03/18		 7.9 MB
金属壳体 的安全开关	102453	11-03/18		 8.2 MB

## CAD data

CAD data for this item on TraceParts