

ITEM 100465 MGB-E-A-100465

Description	Technical data	Accessories	Downloads
-------------	----------------	-------------	-----------



Features

- › Escape release from the danger zone
- › Door handle signal red
- › Extended actuation axis for thicker doors (available optionally)

Escape release

The safety system MGB/MGB2 can be equipped with an escape release module. The escape release enables people shut in to open the locked door from the danger zone. It is only necessary to actuate the door handle. The actuating direction automatically adapts to the actuating direction of the handle module and does not need to be changed. The actuation axis supplied is suitable for profiles up to 40 mm.

Extended actuation axis

Optionally, a 250 mm (instead of 110 mm) long actuation axis 106761 can be ordered for thicker doors or profiles > 40 mm. The axis can be shortened to the required dimension.

Approvals

Mechanical values and environment

Ambient temperature	-20 ... 55 °C
Mechanical life	1 x 10 ⁶

Dimension drawing

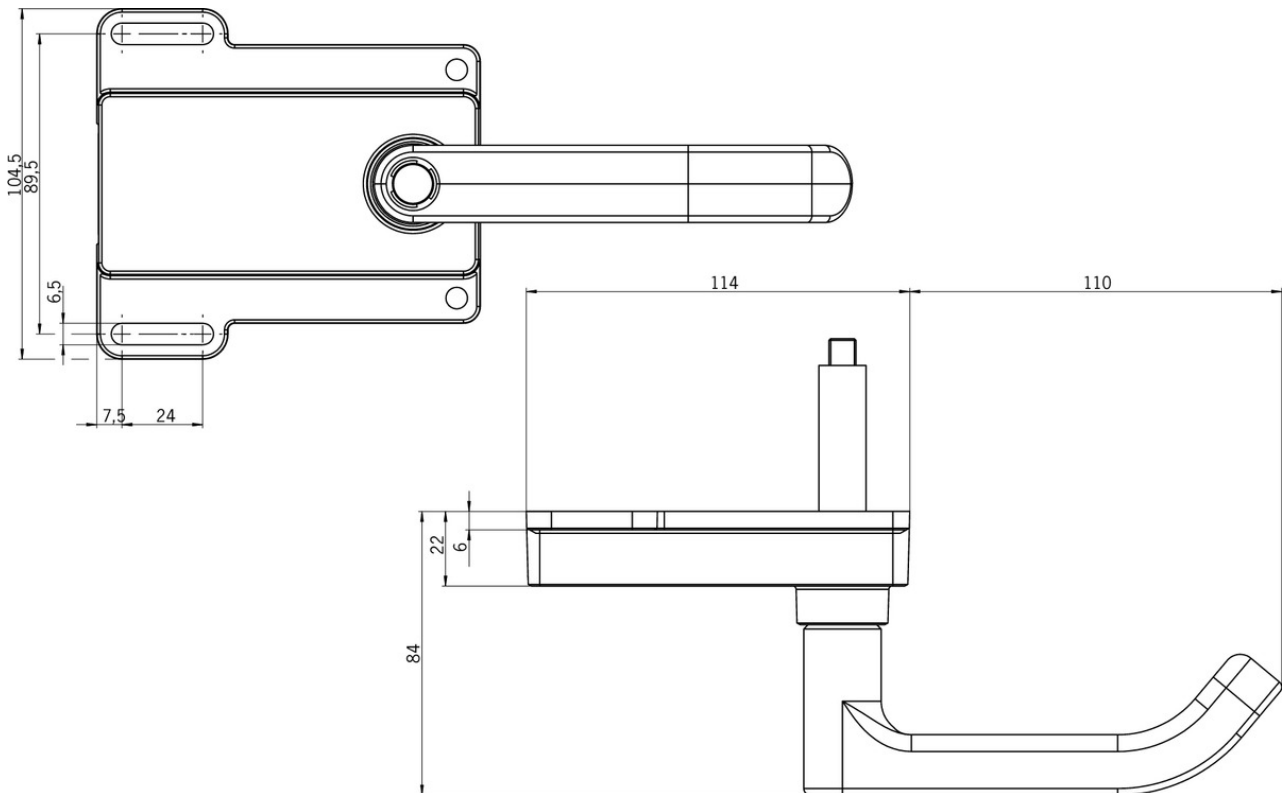

Function expansion

- Extended actuation axis for MGB-E...



106761 AY-ERS-250-106761

- Door knob for MGB-E...



114904 MGB-A-DOORKNOB-R1-114904

Features

- › Aluminum, red painted
- › For mounting on all MGB escape release modules MGB-E
- › e.g. on sliding doors

▼ Door handle for MGB-E...



110276 MGB-A-DOORHANDLE-R1-110276

▼ Features

- › Aluminum, red painted
- › For mounting on all MGB escape release modules MGB-E

Mounting accessories

▼ Mounting plate for escape release



109492 MGB-A-MOUNTINGPLATE-E-109492

▼ Features

- › Easy and quick mounting (only two screws required)
- › Quick module replacement
- › Steel, powder-coated
- › Suitable for doors hinged on the right or left

Catalogs

▼ Multifunctional Gate Box MGB Multifunctional Gate Box MGB Multifunctional Gate Box MGB
 Multifunctional Gate Box MGB Multifunctional Gate Box MGB 多功能系统安全控制系统 MGB

	Doc. no.	Version	Language	Download
Multifunctional Gate Box MGB	106108	10-02/18		8.2 MB
Multifunctional Gate Box MGB	109155	10-02/18		8.2 MB
Multifunctional Gate Box MGB	114433	10-02/18		8.3 MB
Multifunctional Gate Box MGB	121652	10-02/18		8.0 MB
Multifunctional Gate Box MGB	106109	10-02/18		8.2 MB
多功能系统安全控制系统 MGB	155883	10-02/18		8.3 MB







▼ Multifunctional Gate Box MGB2 Modular Multifunctional Gate Box MGB2 Modular Multifunctional Gate Box MGB2 Modular Multifunctional Gate Box MGB2 Modular

	Doc. no.	Version	Language	Download
Multifunctional Gate Box MGB2 Modular	159037	02-09/18		14.3 MB
Multifunctional Gate Box MGB2 Modular	159050	02-09/18		14.4 MB
Multifunctional Gate Box MGB2 Modular	159051	02-09/18		14.4 MB
Multifunctional Gate Box MGB2 Modular	159039	02-09/18		14.4 MB

Declaration of conformity

▼ EU-Konformitätserklärung

Doc. no.	Version	Language	Download
----------	---------	----------	----------

EU-Konformitätserklärung	2123150	08-01/17		 0.3 MB
Declaración UE de conformidad				
Déclaration UE de conformité				
Dichiarazione di conformità				
EU declaration of conformity				

CAD data

CAD data for this item on TraceParts