

ITEM 110355 RIEGEL CES-AC-AP-C01-CH-SB-110355

Description	Technical data	Accessories	Downloads
-------------	----------------	-------------	-----------

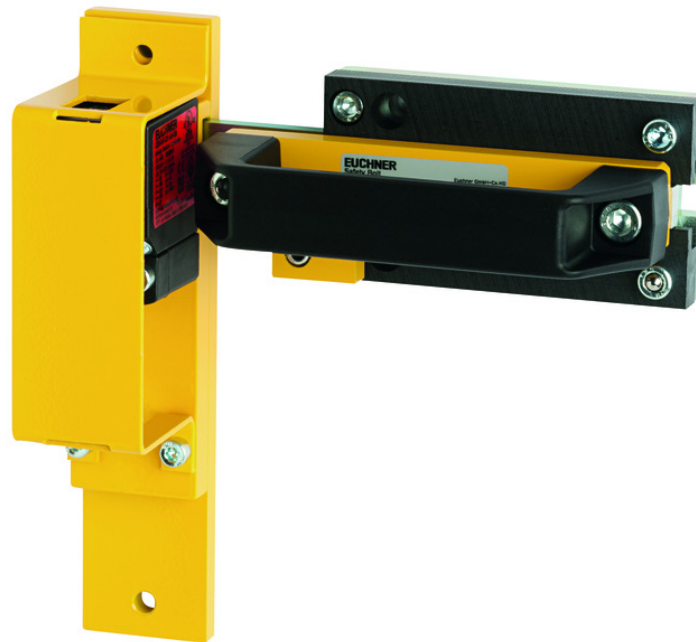

Features

- › Steel bolt
- › Safety switch already pre-assembled
- › Connection via M12 plug connector
- › For left or right hinged doors
- › Ball detent mechanism in closed position
- › Can be locked in open position with padlocks
- › Switch and actuator included

Advantages

- › Robust construction
- › Easily fitted to standard aluminum profiles and machine covers by screw connection
- › Distinctive yellow color for easy recognition
- › Symmetrical design for doors hinged on the right or left
- › No additional door handle necessary

Notes

- › CES actuator integrated in the bolt tongue

- › Safety switch CES-AP-C01-CH-SB-106798 included. For further information see product page for the safety switch.

Special features

- › Multicode safety switch (no teach-in operation necessary)
- › Bolt with detent mechanism - Ball detent mechanism in closed bolt position - Protection against vibration

Components included in the set



106798 Safety switch CES-AP-C01-CH-SB-106798
 Features

Mechanical values and environment

Material	Handle	Plastic
	Guide strips	Plastic
	Base plate	Galvanized steel
	Switch bracket	Steel powder-coated
Weight	Net	2 kg
	Escape release	Yes
Number of safety switches that can be fitted		1

Miscellaneous

Detent mechanism	Closed position	Ball detent mechanism
------------------	-----------------	-----------------------

Dimension drawing

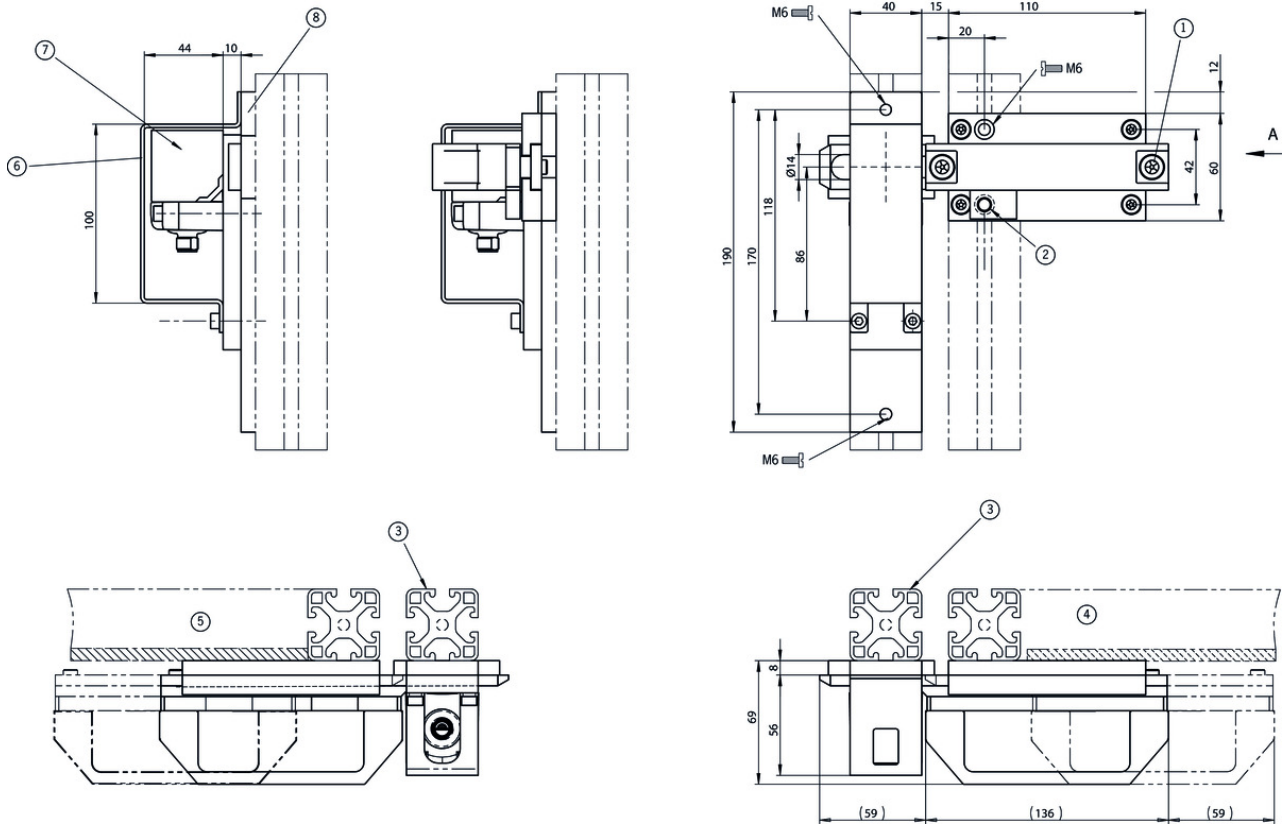

Legende

- 1 Screw secured against loosening
- 2 Detent mechanism against accidental opening (vibration)
- 3 Safety guard frame (40x40)
- 4 Door hinged on the right
- 5 Door hinged on the left
- 6 Protective plate mounted on switch bracket.
- 7 Safety switch mounted on switch bracket.
- 8 Stop plate

Connection material

- ☑ Connection cable with straight plug connector M12, 5-pin, 5m



100183 C-M12F05-05X034PV05,0-MA-100183

☑ Features

- › M12 female plug, 5-pin
- › Straight plug connector
- › PVC cable
- › Cable length 5 m
- › With flying lead

▼ Connection cable with plug connector M12, 5-pin, 10m



100184 C-M12F05-05X034PV10,0-MA-100184

▼ Features

- › M12 female plug, 5-pin
- › Straight plug connector
- › PVC cable
- › Cable length 10 m
- › With flying lead

▼ Connection cable with plug connector M12, 5-pin, 20m



100185 C-M12F05-05X034PV20,0-MA-100185

▼ Features

- › M12 female plug, 5-pin
- › Straight plug connector
- › PVC cable
- › Cable length 20 m
- › With flying lead



















Instructions

▼ Návod k použití Bezkontaktní bezpečnostní spínač CES-AP-C01-... (Unicode/Multicode)





	Doc. no.	Version	Language	Download
Betriebsanleitung Berührungsloser Sicherheitsschalter CES-AP-C01-... (Uni-/Multicode)	2112663	06-10/17		1.5 MB
Mode d'emploi Interrupteur de sécurité sans contact CES-AP-C01-... (uni-/multicode)	2112663	06-10/17		1.5 MB
Manual de instrucciones Interruptor de seguridad sin contacto CES-AP-C01-... (Unicode/Multicode)	2112663	06-10/17		1.5 MB
Návod k použití Bezkontaktní bezpečnostní spínač CES-AP-C01-... (Unicode/Multicode)	2112663	06-10/17		1.6 MB
Operating Instructions Non-Contact Safety Switch CES-AP-C01-... (Unicode/Multicode)	2112663	06-10/17		1.5 MB
Kezelési útmutató Érintkezésmentes biztonsági kapcsoló CES-AP-C01-... (uni-/multikód)	2112663	06-10/17		1.6 MB
Istruzioni di impiego Finecorsa di sicurezza senza contatto CES-AP-C01-... (Unicode/Multicode)	2112663	06-10/17		1.5 MB
Instrukcja obsługi Bezstykowy wyłącznik bezpieczeństwa CES-AP-C01-... (Uni-/Multicode)	2112663	06-10/17		1.6 MB
Инструкция по эксплуатации Бесконтактный предохранительный выключатель CES-AP-C01-... (Uni-/Multicode)	2112663	06-10/17		1.7 MB

Návod na prevádzku Bezdotykový bezpečnostný spínač CES-AP-C01-... (Uni-/Multicode)	2112663	06-10/17		 1.6 MB
使用说明书 非接触式安全开关 CES-AP-C01-... (特殊/通用编码)	2112663	06-10/17		 1.7 MB
Manual de instruções Chaves de segurança sem contato CES-AP-C01-... (Unicode/Multicode)	2112663	06-10/17		 1.5 MB

▼ Sicherheitsinformation CES-AR/CES-AP

	Doc. no.	Version	Language	Download
Sicherheitsinformation CES-AR/CES-AP	091181	08-04/15		 0.6 MB
Información de seguridad CES-AR/CES-AP				
Information de sécurité CES-AR/CES-AP				
Informazioni sulla sicurezza CES-AR/CES-AP				
Safety Information CES-AR/CES-AP				
Informații privind siguranța CES-AR/CES-AP	091181	08-04/15		 0.2 MB
Informação de segurança CES-AR/CES-AP	091181	08-04/15		 0.2 MB
Bezpečnostní informace CES-AR/CES-AP	091181	08-04/15		 0.2 MB
安全信息 CES-AR/CES-AP	091181	08-04/15		 0.3 MB
Информация о безопасности CES-AR/CES-AP	091181	08-04/15		 0.2 MB
Güvenlik bilgisi CES-AR/CES-AP	091181	08-04/15		 0.2 MB

▼ Sicherheitsinformation CES-AR/CES-AP/CES-BR

	Doc. no.	Version	Language	Download
Sicherheitsinformation CES-AR/CES-AP/CES-BR	2514431	02-07/18		 0.4 MB
Safety Information CES-AR/CES-AP/CES-BR				
Information de sécurité CES-AR/CES-AP/CES-BR				

Catalogs

▼ Transpondercodierte Sicherheitsschalter - Verriegelungseinrichtungen und Zuhaltungen Transponder-coded safety switches - Interlocking devices and guard locking devices Interruptores de seguridad con codificación por transponder - Dispositivos de enclavamiento y bloqueos Interrupteurs de sécurité à codage par transpondeur - Dispositifs de verrouillage et interverrouillages

	Doc. no.	Version	Language	Download
Transpondercodierte Sicherheitsschalter - Verriegelungseinrichtungen und Zuhaltungen	127594	02-01/18		 5.2 MB
Interrupteurs de sécurité à codage par transpondeur - Dispositifs de verrouillage et interverrouillages	137558	02-01/18		 5.2 MB
Interruptores de seguridad con codificación por transponder - Dispositivos de enclavamiento y bloqueos	137560	02-01/18		 5.2 MB
Transponder-coded safety switches - Interlocking devices and guard locking devices	127595	02-01/18		 5.1 MB



Declaration of conformity

▼ EU prohlášení o shodě

Doc. no.	Version	Language	Download
----------	---------	----------	----------

EU-Konformitätserklärung Declaración UE de conformidad Déclaration UE de conformité Dichiarazione di conformità EU declaration of conformity	2109923	13-01/17	    	 0.4 MB
EU prohlášení o shodě EU-overensstemmelseserklæring Δήλωση συμμόρφωσης της ΕΕ EU-vaatimustenmukaisuusvakuutus EU-típusbizonyítvány EU-conformiteitsverklaring Deklaracja zgodności UE Declarația de conformitate UE EÚ vyhlásenie o zhode	2109923	13-01/17	       	 0.6 MB

 EU-Konformitätserklärung

	Doc. no.	Version	Language	Download
EU-Konformitätserklärung Declaración UE de conformidad Déclaration UE de conformité Dichiarazione di conformità EU declaration of conformity	2138160	01-01/17	    	 0.3 MB

CAD data

CAD data for this item on TraceParts