

ITEM 099425 EMP-L-CEM05

Description	Technical data	Accessories	Downloads
-------------	----------------	-------------	-----------

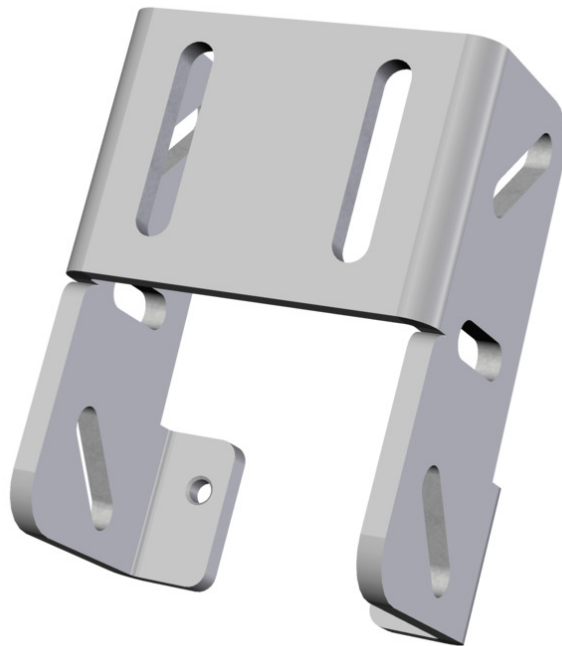

Features

- › For read head CEM-A-LE05...
- › Material stainless steel

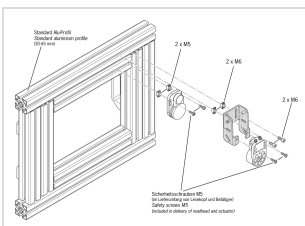

› Installation example mounting plate EMP
Hinged door

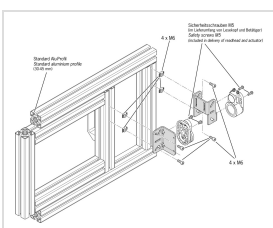

› Figure
Sliding door

Mechanical values and environment

Material	Stainless steel
Weight	Net 0,25 kg

Dimension drawing

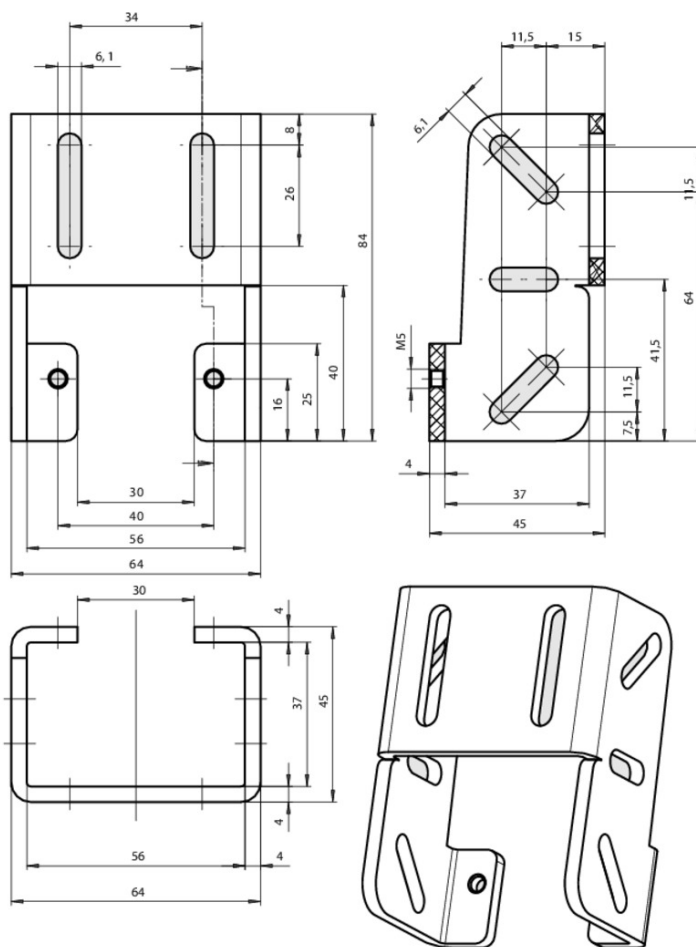

Mounting accessories

✓ Mounting plates EMP-B1 for actuators for safety switches CTP, TP...A, STA, STP, TX and TZ



093457 EMP-B1



- Mounting plates EMP-B2 for actuators for safety switches CTP, TP...A, STA, STP, TX and TZ



093458 EMP-B2









Instructions

- Montageanleitung Montageplatten für Sicherheitsschalter CEM

	Doc. no.	Version	Language	Download
Montageanleitung Montageplatten für Sicherheitsschalter CEM Assembly Instructions mounting plates CEM	098576	01-08/07	 	 0.4 MB

Catalogs

- Transpondercodierte Sicherheitssysteme mit externer Auswertung Transponder-coded safety systems with external evaluation Sistemas de seguridad con codificación por transponder y evaluación externa Systèmes de sécurité à codage par transpondeur avec analyse externe

	Doc. no.	Version	Language	Download
Transpondercodierte Sicherheitssysteme mit externer Auswertung	127596	02-01/18		 3.1 MB
Systèmes de sécurité à codage par transpondeur avec analyse externe	137968	02-01/18		 3.0 MB
Sistemas de seguridad con codificación por transponder y evaluación externa	139969	02-01/18		 3.0 MB
Transponder-coded safety systems with external evaluation	127597	02-01/18		 3.0 MB

CAD data

CAD data for this item on TraceParts