

## ITEM 106634 MONTAGEMATERIAL 10-NUT BOSCH

Description	Technical data	Accessories	Downloads
-------------	----------------	-------------	-----------

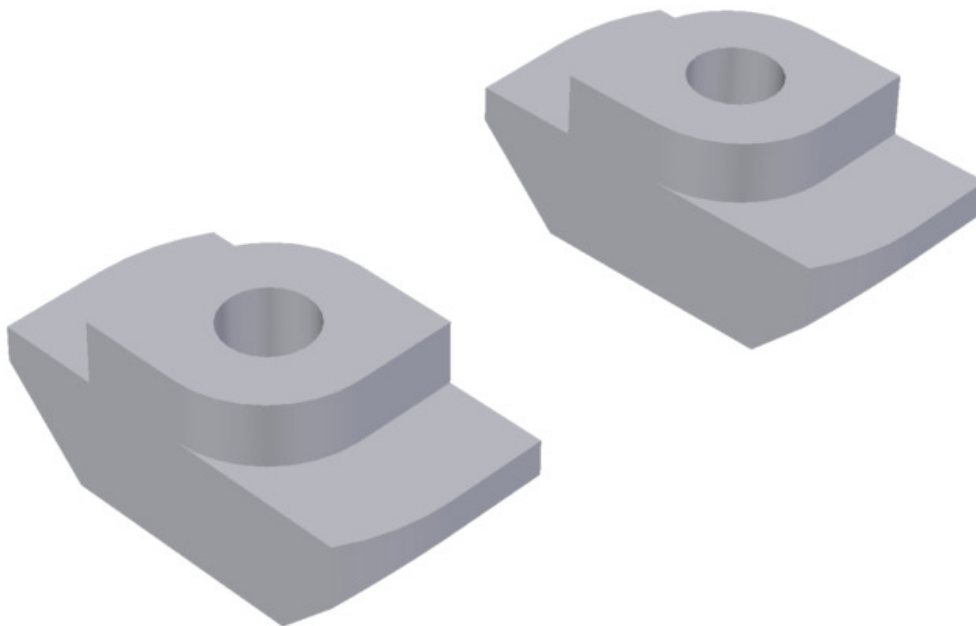

### Features

- › For Bosch profiles with 8 mm groove
- › For Bosch profiles with 10 mm groove
- › For ITEM profiles with 8 mm groove
- › 2 screws and 2 clamping pieces each

### Components included in the set

Supplied accessories









2x DIN 7991 M5x12 8.8-Zn, 2x clamping piece M5 black galvanized

### Miscellaneous

Compatibility	CES-A-LSP-...
---------------	---------------

## Catalogs

- ✓ Transpondercodierte Sicherheitssysteme mit externer Auswertung Transponder-coded safety systems with external evaluation Sistemas de seguridad con codificación por transponder y evaluación externa Systèmes de sécurité à codage par transpondeur avec analyse externe

	Doc. no.	Version	Language	Download
Transpondercodierte Sicherheitssysteme mit externer Auswertung	127596	02-01/18		 3.1 MB
Systèmes de sécurité à codage par transpondeur avec analyse externe	137968	02-01/18		 3.0 MB
Sistemas de seguridad con codificación por transponder y evaluación externa	139969	02-01/18		 3.0 MB
Transponder-coded safety systems with external evaluation	127597	02-01/18		 3.0 MB