

## ITEM 086236 SCHLOSS TP GLEICHSCHLIESSEND

Description	Technical data	Accessories	Downloads
-------------	----------------	-------------	-----------



### Features

- › Identical locking
- › Key removable in "unlocked" and "locked" positions

The lock is used in combination with safety switch CTP/TP/STP. The mechanical key release enables authorized personnel to actuate the mechanical release using the related key. The unlocking mechanism holds the solenoid in the "unlocked" position. Two screws are used to fix the lock to the cover of the safety switch (above the auxiliary release).

- › Order safety switch CTP/TP/STP separately
- › 2 keys are included
- › Every safety switch of the series CTP/TP/ STP can be upgraded to include a lock

### Mechanical values and environment

Material	Plastic [1]
Removal position	two [2]
Closing type	Identical locking

- [1] Lock: Metal
- [2] 0° and 180°

**Dimension drawing**

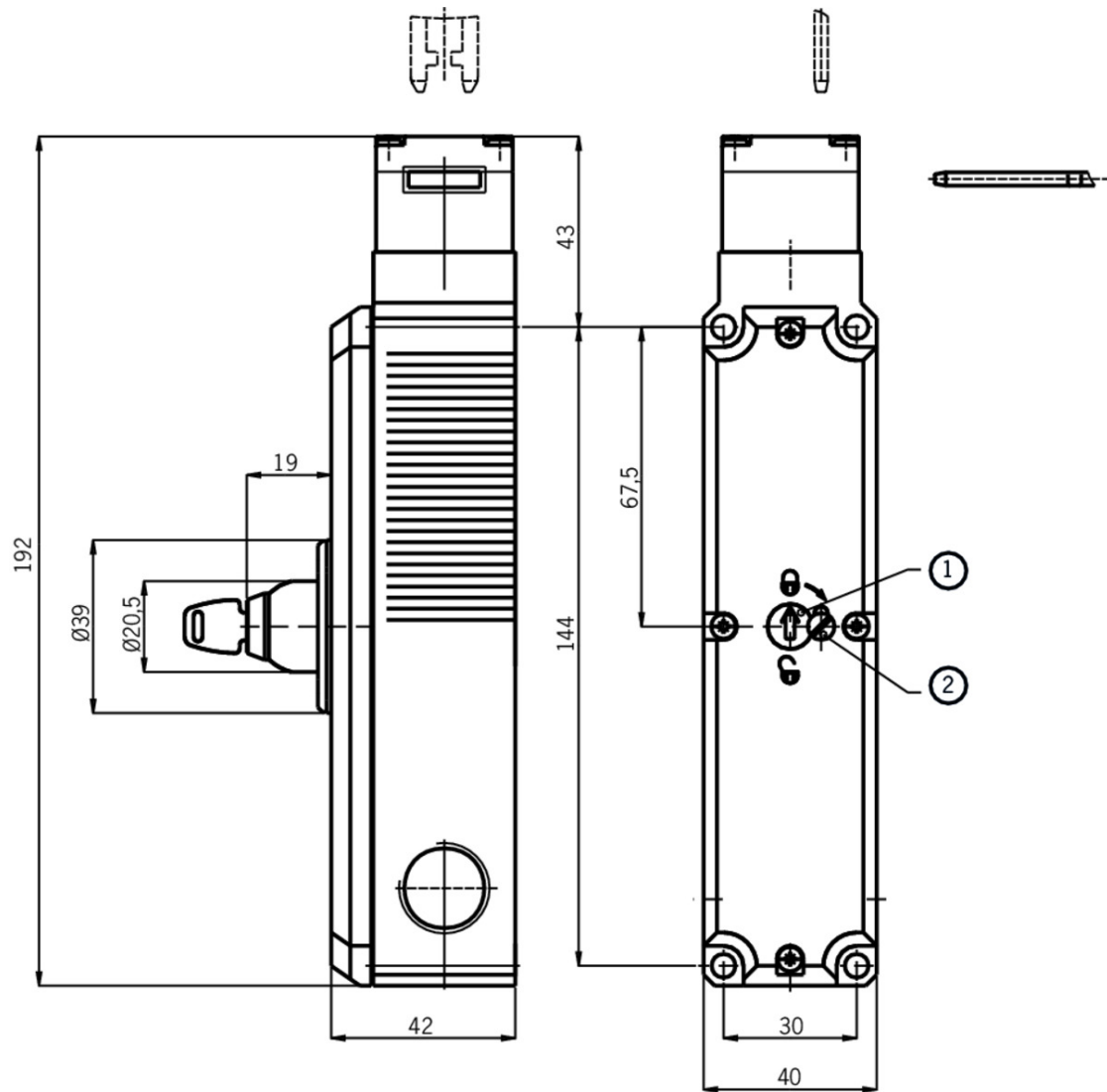

**Legende**

- 1 Auxiliary release (basic position)
- 2 Locking screw

## Dimension drawing

A-A 1:1

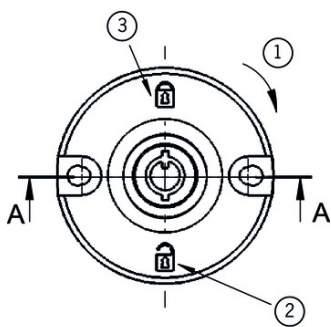
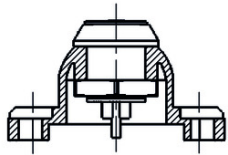

## Legende

- 1 Direction of rotation
- 2 unlocked
- 3 Locked

## Spare parts







- Replacement key for mechanical key release















**099434** ERSATZSCHLUESSEL GLEICHSCHL.0354

## Catalogs









- ▼ Transpondercodierte Sicherheitsschalter - Verriegelungseinrichtungen und Zuhaltungen  
Transponder-coded safety switches - Interlocking devices and guard locking devices  
Interruptores de seguridad con codificación por transponder - Dispositivos de enclavamiento y bloqueos  
Interrupteurs de sécurité à codage par transpondeur - Dispositifs de verrouillage et interverrouillages

	Doc. no.	Version	Language	Download
Transpondercodierte Sicherheitsschalter - Verriegelungseinrichtungen und Zuhaltungen	127594	02-01/18		 5.2 MB
Interrupteurs de sécurité à codage par transpondeur - Dispositifs de verrouillage et interverrouillages	137558	02-01/18		 5.2 MB
Interruptores de seguridad con codificación por transponder - Dispositivos de enclavamiento y bloqueos	137560	02-01/18		 5.2 MB
Transponder-coded safety switches - Interlocking devices and guard locking devices	127595	02-01/18		 5.1 MB

- ▼ Bezpečnostní spínače s plastovým pouzdrém Sicherheitsschalter mit Kunststoffgehäuse Safety Switches with Plastic Housing Interruptores de seguridad con carcasa plástica Interrupteurs de sécurité avec boîtier plastique 塑料壳体 的安全开关

	Doc. no.	Version	Language	Download
Sicherheitsschalter mit Kunststoffgehäuse	096955	11-03/18		 6.6 MB
Interrupteurs de sécurité avec boîtier plastique	100677	11-03/18		 6.6 MB
Interruptores de seguridad con carcasa plástica	104855	11-03/18		 6.6 MB
Bezpečnostní spínače s plastovým pouzdrém	121649	11-03/18		 6.6 MB
Safety Switches with Plastic Housing	096956	11-03/18		 6.6 MB
塑料壳体 的安全开关	116243	11-03/18		 6.2 MB

- ▼ Multifunctional Gate Box MGB2 Modular Multifunctional Gate Box MGB2 Modular Multifunctional Gate Box MGB2 Modular Multifunctional Gate Box MGB2 Modular

	Doc. no.	Version	Language	Download
Multifunctional Gate Box MGB2 Modular	159037	02-09/18		 14.3 MB
Multifunctional Gate Box MGB2 Modular	159050	02-09/18		 14.4 MB
Multifunctional Gate Box MGB2 Modular	159051	02-09/18		 14.4 MB
Multifunctional Gate Box MGB2 Modular	159039	02-09/18		 14.4 MB

## CAD data

CAD data for this item on TraceParts