

ITEM 077014 C-M23F19-19XDIFPU06,0-MA-077014

| Description | Technical data | Accessories | Downloads |
|-------------|----------------|-------------|-----------|
|-------------|----------------|-------------|-----------|



Features

- › M23 plug connector, 18-pin + PE
- › Straight plug connector
- › PUR cable
- › Cable length 6 m
- › With flying lead
- › Cores color-coded

Connector assignment

| Plug connector (view of connection side) | Pin | Cross-section | Conductor coloring |
|--|-----|------------------|--------------------|
| | 1 | 0.5 ² | VT |
| | 2 | 0.5 ² | RD |
| | 3 | 0.5 ² | GY |
| | 4 | 0.5 ² | RDBU |
| | 5 | 0.5 ² | GN |
| | 6 | 1.0 ² | BU |

| Plug connector (view of connection side) | Pin | Cross-section | Conductor coloring |
|--|-----|------------------|--------------------|
| | 7 | 0.5 ² | GYPK |
| | 8 | 0.5 ² | GNWH |
| | 9 | 0.5 ² | YEWH |
| | 10 | 0.5 ² | GYWH |
| | 11 | 0.5 ² | BK |
| | 12 | 1.0 ² | GNYE |
| | 13 | 0.5 ² | PK |
| | 14 | 0.5 ² | BNGY |
| | 15 | 0.5 ² | BNYE |
| | 16 | 0.5 ² | BNGN |
| | 17 | 0.5 ² | WH |
| | 18 | 0.5 ² | YE |
| | 19 | 1.0 ² | BN |

Approvals



Mechanical values and environment

| | |
|-------------------------------|--|
| Sheath material | PUR |
| Conductor insulation material | PP |
| Conductor material | Bare Cu flexible wire super fine strands |
| Fire behavior | Flame retardant according to DIN EN 60332-1-2 |
| Drag chain suitability | Yes |
| Ambient temperature | Dynamic -20 ... +80 °C static -20 ... +80 °C |
| Number of conductors | 19 |
| Type of cable | straight |
| Cable length | 6 m |
| Cable diameter | Approx. 10,4 mm |
| Conductor cross-section | 16 x 0.5 mm ² / 3 x 1 mm ² |
| Conductor identification | Color code |
| Sheath color | Black |
| Bending radius | Dynamic 10x cable diameter |
| | Connection 1 |

| | |
|-------------------------------|------------------------|
| Degree of protection | IP65 / IP67 [1] |
| Plug lock material | CuZn, nickel-plated |
| Designation of plug connector | RC [2] |
| Insertion cycles | 50 |
| Connection | Plug connector M23 |
| Connection type | Socket |
| Cable outlet | straight |
| Number of pins | 19 [3] |
| Plug lock | Screw connection |
| Plug housing material | CuZn, nickel-plated |
| | Connection 2 |
| Conductor end | Sheath stripped |
| Connection | Flying lead |

Electrical connection ratings

| | |
|--|---------------------|
| Rated voltage | 150 V |
| Overtoltage category according to IEC EN 60664-1 | II |
| Test voltage | 1,5 kV |
| | Connection 1 |
| Degree of contamination according to EN 60664-1 | 3 |

[1] Locked

[2] With screen bonding clamp

[3] 18+PE

Dimension drawing

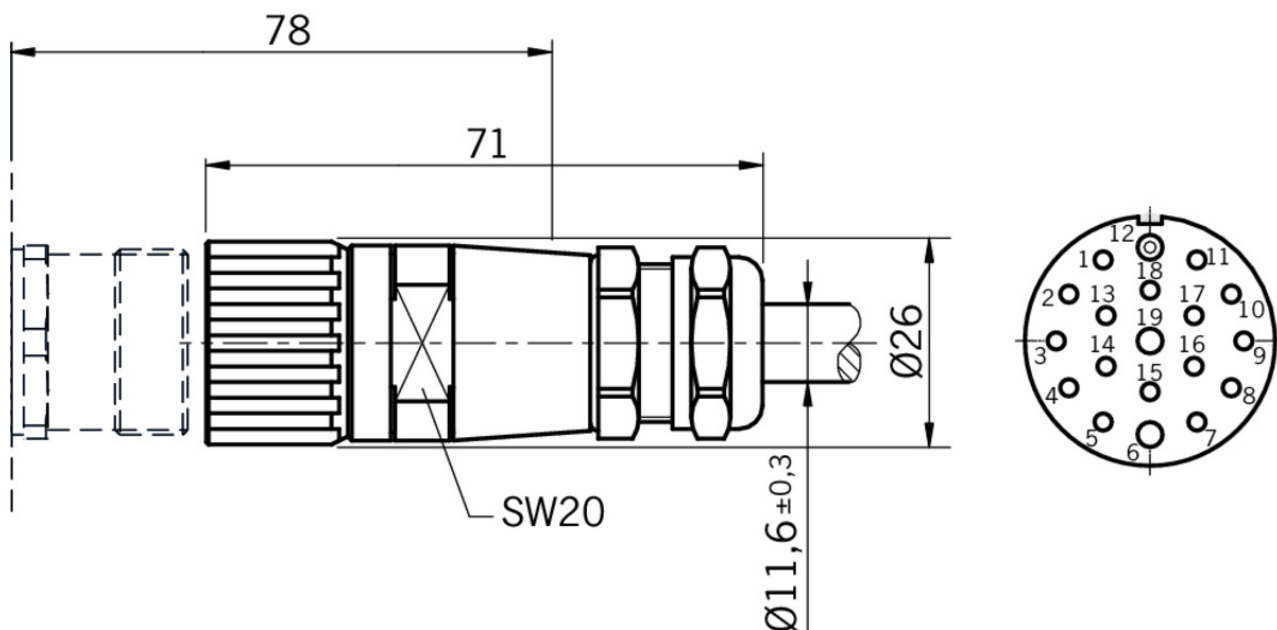

Connection material

- ✓ Coupling socket RC18, straight, with option C1825



129500 RC18EM-C1825

✓ Features

- › Coupling socket M23, straight
- › Number of pins: 19-pin with screen bonding clamp
- › Suitable for extension of plug RC18EF-1825, RC18WF-1825
- › Replacement crimp contacts available as item number 155811.

Catalogs

- ✓ Multifunctional Gate Box MGB Multifunctional Gate Box MGB Multifunctional Gate Box MGB Multifunctional Gate Box MGB 多功能系统安全控制系统 MGB













| | Doc. no. | Version | Language | Download |
|------------------------------|----------|----------|----------|----------|
| Multifunctional Gate Box MGB | 106108 | 10-02/18 | | 8.2 MB |
| Multifunctional Gate Box MGB | 109155 | 10-02/18 | | 8.2 MB |
| Multifunctional Gate Box MGB | 114433 | 10-02/18 | | 8.3 MB |
| Multifunctional Gate Box MGB | 121652 | 10-02/18 | | 8.0 MB |
| Multifunctional Gate Box MGB | 106109 | 10-02/18 | | 8.2 MB |
| 多功能系统安全控制系统 MGB | 155883 | 10-02/18 | | 8.3 MB |

- ✓ Transpondercodierte Sicherheitsschalter - Verriegelungseinrichtungen und Zuhaltungen
Transponder-coded safety switches - Interlocking devices and guard locking devices
Interruptores de seguridad con codificación por transponder - Dispositivos de enclavamiento y













bloqueos Interruptores de seguridad à codage par transpondeur - Dispositifs de verrouillage et interverrouillages

| | Doc. no. | Version | Language | Download |
|---|----------|----------|---|--|
| Transpondercodierte Sicherheitsschalter - Verriegelungseinrichtungen und Zuhaltungen | 127594 | 02-01/18 |  |  5.2 MB |
| Interrupteurs de sécurité à codage par transpondeur - Dispositifs de verrouillage et interverrouillages | 137558 | 02-01/18 |  |  5.2 MB |
| Interruptores de seguridad con codificación por transponder - Dispositivos de enclavamiento y bloqueos | 137560 | 02-01/18 |  |  5.2 MB |
| Transponder-coded safety switches - Interlocking devices and guard locking devices | 127595 | 02-01/18 |  |  5.1 MB |

 Bezpečnostní spínače s plastovým pouzdem Sicherheitsschalter mit Kunststoffgehäuse Safety Switches with Plastic Housing Interruptores de seguridad con carcasa plástica Interrupteurs de sécurité avec boîtier plastique 塑料壳体 的安全开关

| | Doc. no. | Version | Language | Download |
|--|----------|----------|---|--|
| Sicherheitsschalter mit Kunststoffgehäuse | 096955 | 11-03/18 |  |  6.6 MB |
| Interrupteurs de sécurité avec boîtier plastique | 100677 | 11-03/18 |  |  6.6 MB |
| Interruptores de seguridad con carcasa plástica | 104855 | 11-03/18 |  |  6.6 MB |
| Bezpečnostní spínače s plastovým pouzdem | 121649 | 11-03/18 |  |  6.6 MB |
| Safety Switches with Plastic Housing | 096956 | 11-03/18 |  |  6.6 MB |
| 塑料壳体 的安全开关 | 116243 | 11-03/18 |  |  6.2 MB |

 Sicherheitsschalter mit Metallgehäuse Safety Switches with Metal Housing Bezpečnostní spínače s kovovým pouzdem Interrupteurs de sécurité avec boîtier métallique 金属壳体 的安全开关 Interruptores de seguridad con carcasa metálica

| | Doc. no. | Version | Language | Download |
|---|----------|----------|---|---|
| Sicherheitsschalter mit Metallgehäuse | 100319 | 11-03/18 |  |  7.9 MB |
| Interrupteurs de sécurité avec boîtier métallique | 100676 | 11-03/18 |  |  7.9 MB |
| Interruptores de seguridad con carcasa metálica | 104856 | 11-03/18 |  |  14.0 MB |
| Safety Switches with Metal Housing | 100369 | 11-03/18 |  |  7.9 MB |
| Bezpečnostní spínače s kovovým pouzdem | 121650 | 11-03/18 |  |  7.9 MB |
| 金属壳体 的安全开关 | 102453 | 11-03/18 |  |  8.2 MB |

CAD data

CAD data for this item on TraceParts