

ITEM 110306 C-M23F19-19XDIFPU20,0-MA-110306

Description	Technical data	Accessories	Downloads
-------------	----------------	-------------	-----------



Features

- › M23 female plug, 19-pin
- › Straight plug connector
- › PUR cable
- › Cable length 20 m
- › With flying lead
- › Cores numbered, black

Connector assignment

Plug connector (view of connection side)	Pin	Cross-section	Numbering imprinted
	1	0.5 ²	1
	2	0.5 ²	2
	3	0.5 ²	3
	4	0.5 ²	4
	5	0.5 ²	5
	6	1.0 ²	6

Plug connector (view of connection side)	Pin	Cross-section	Numbering imprinted
	7	0.5 ²	7
	8	0.5 ²	8
	9	0.5 ²	9
	10	0.5 ²	10
	11	0.5 ²	11
	12	1.0 ²	12
	13	0.5 ²	13
	14	0.5 ²	14
	15	0.5 ²	15
	16	0.5 ²	16
	17	0.5 ²	17
	18	0.5 ²	18
	19	1.0 ²	19

Mechanical values and environment

Sheath material	PUR
Conductor insulation material	PVC
Conductor material	EL-Cu flexible wire bare super fine strands
Fire behavior	Flame retardant according to VDE 0472 804
Drag chain suitability	Yes
Ambient temperature	Dynamic -20 ... +90 °C static -40 ... +90 °C
Number of conductors	19
Type of cable	straight
Cable length	20 m
Cable diameter	Approx. 11,4 mm
Conductor cross-section	16x 0.5 mm ² + 3x 1 mm ²
Conductor identification	Numeric code
Sheath color	Black
Bending radius	Dynamic 10x cable diameter
	Connection 1
Degree of protection	IP65 / IP67 [1]
Plug lock material	CuZn, nickel-plated
Designation of plug connector	RC
Insertion cycles	50
Connection	Plug connector M23

Connection type	Socket
Cable outlet	straight
Number of pins	19 [2]
Plug lock	Screw connection
Plug housing material	CuZn, nickel-plated
	Connection 2
Conductor end	Sheath stripped
Connection	Flying lead

Electrical connection ratings

Rated voltage	150 V
Overvoltage category according to IEC EN 60664-1	II
Test voltage	1,5 kV
	Connection 1
Degree of contamination according to EN 60664-1	3

[1] Locked





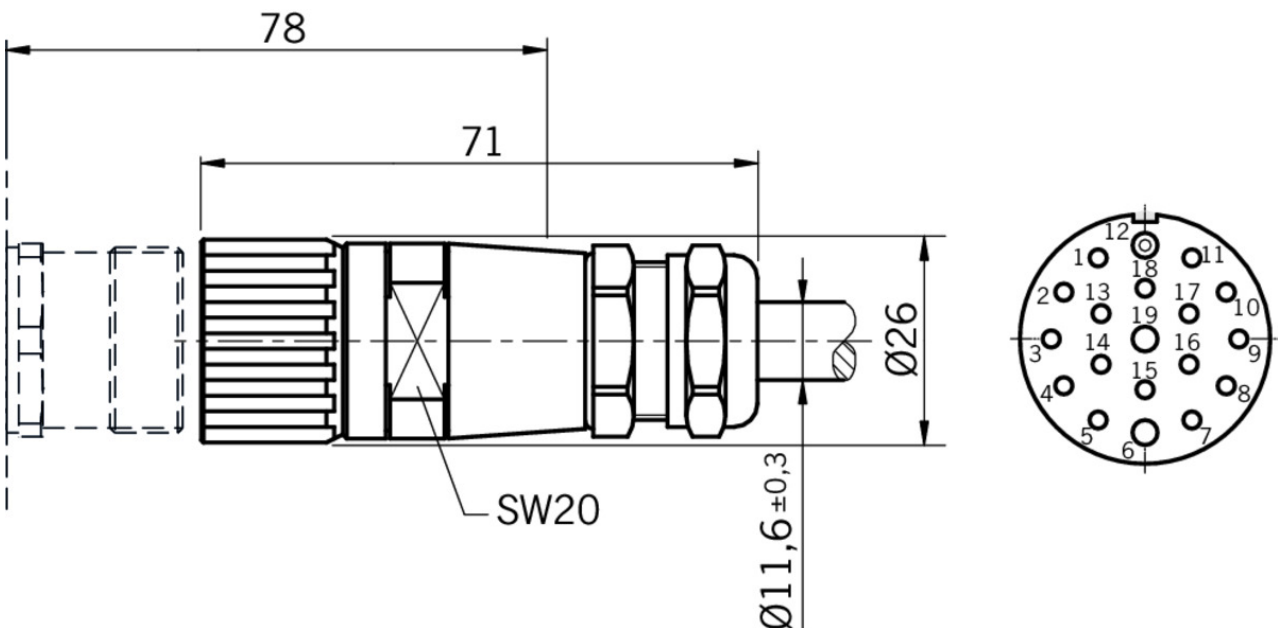







[2] 16+3

Dimension drawing



Catalogs

☑ Multifunctional Gate Box MGB Multifunctional Gate Box MGB Multifunctional Gate Box MGB
Multifunctional Gate Box MGB Multifunctional Gate Box MGB 多功能系统安全控制系统 MGB

	Doc. no.	Version	Language	Download
Multifunctional Gate Box MGB	106108	10-02/18		 8.2 MB
Multifunctional Gate Box MGB	109155	10-02/18		 8.2 MB
Multifunctional Gate Box MGB	114433	10-02/18		 8.3 MB
Multifunctional Gate Box MGB	121652	10-02/18		 8.0 MB
Multifunctional Gate Box MGB	106109	10-02/18		 8.2 MB
多功能系统安全控制系统 MGB	155883	10-02/18		 8.3 MB