

**ITEM 077639 C-R22F07-07X1,0PU10,0-MA-077639**

Description	Technical data	Accessories	Downloads
-------------	----------------	-------------	-----------



**Features**

- › Female plug SR6, 6-pin + PE
- › Angled plug connector
- › PUR cable
- › Cable length 10 m
- › With flying lead

**Connector assignment**

SR6

1	1
2	2
3	3
4	4
5	5
6	6
	7



## Mechanical values and environment

Sheath material	PUR
Drag chain suitability	No
Ambient temperature	
Dynamic	-5 ... +70 °C
static	-40 ... +80 °C
Number of conductors	7
Type of cable	straight
Cable length	10 m
Cable diameter	
Approx.	8 mm
Conductor cross-section	1 mm <sup>2</sup>
Bending radius	
Dynamic	12.5 x outer diameter
static	4 x outer diameter
	<b>Connection 1</b>
Degree of protection	IP65 [1]
Connection	Plug connector M26 x 1.5
Connection type	Socket
Cable outlet	Angle
Number of pins	7 [2]
Plug lock	Screw connection
Plug housing material	PET
	<b>Connection 2</b>
Conductor end	Sheath stripped
Connection	Flying lead

## Electrical connection ratings

Rated voltage	250 V
Test voltage	4 kV

[1] Only in the screwed tight state

[2] 6+PE

# Dimension drawing

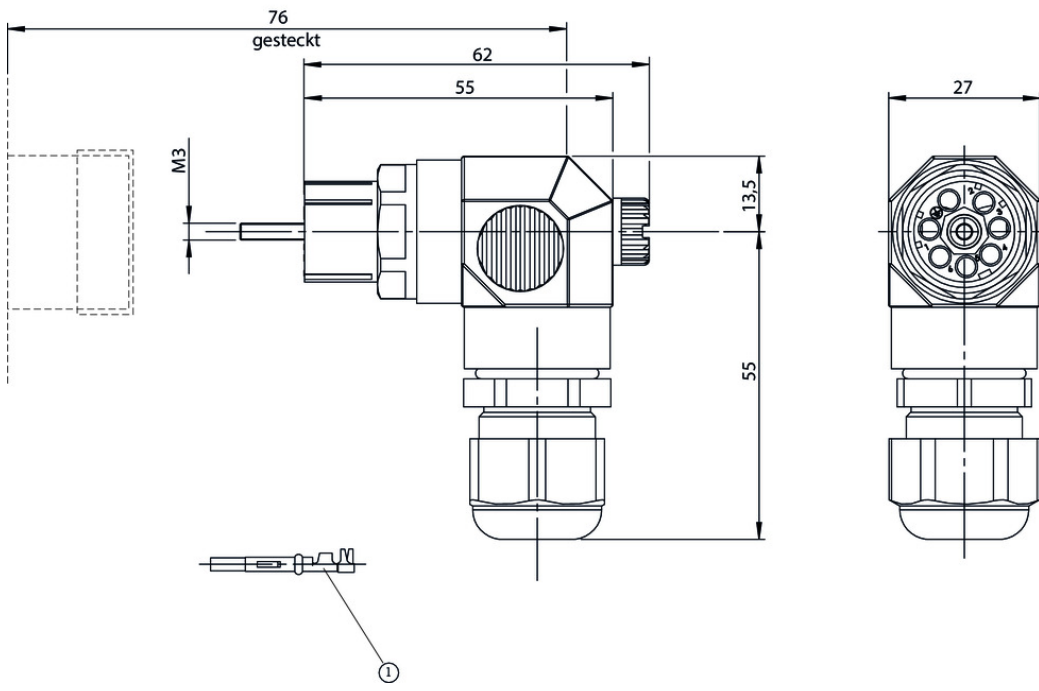

## Dimension drawing

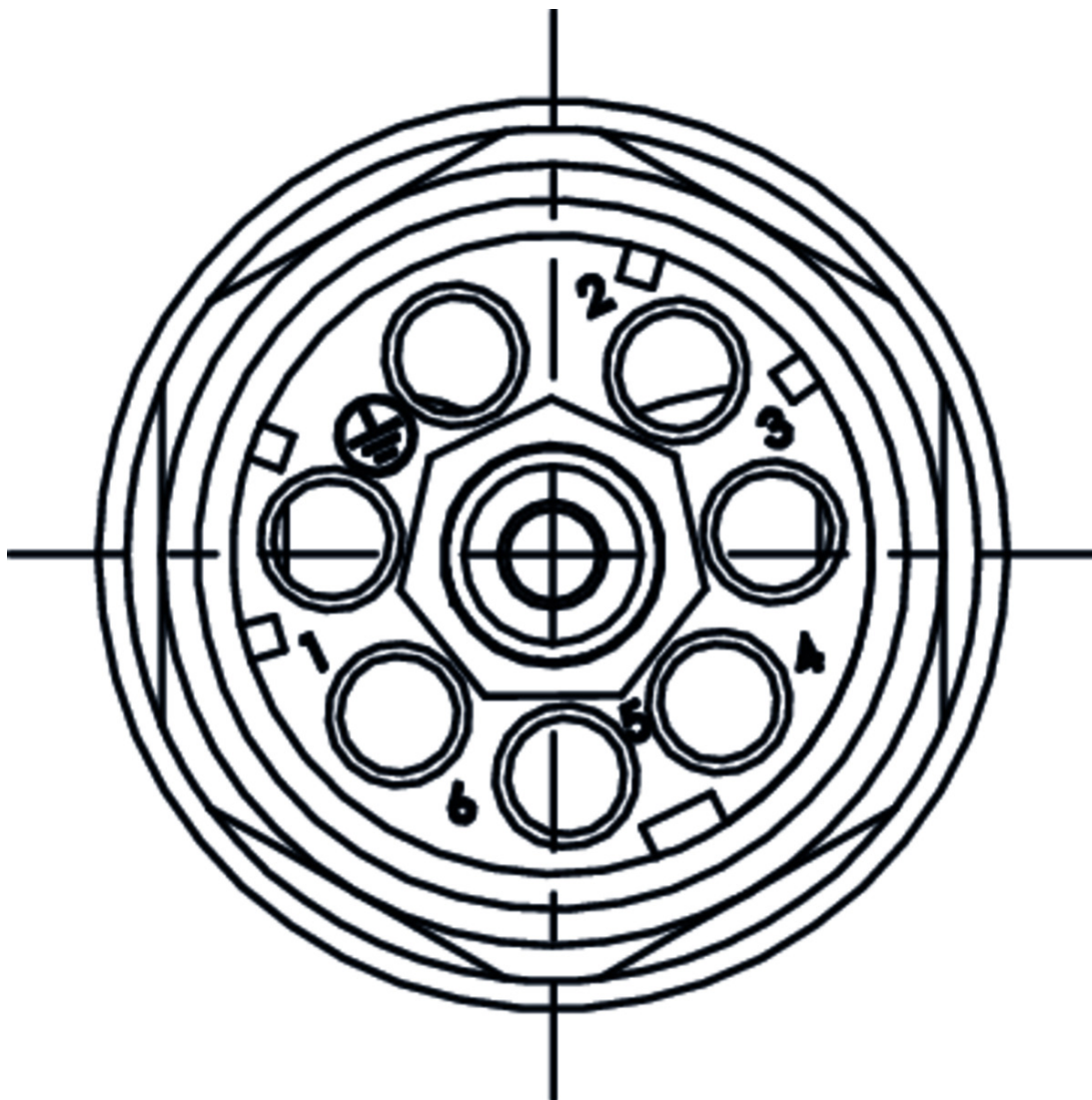













## Catalogs

- Bezpečnostní spínače s plastovým pouzdrém Sicherheitsschalter mit Kunststoffgehäuse Safety Switches with Plastic Housing Interruptores de seguridad con carcasa plástica Interrupteurs de sécurité avec boîtier plastique 塑料壳体的安全开关

	Doc. no.	Version	Language	Download
Sicherheitsschalter mit Kunststoffgehäuse	096955	11-03/18		6.6 MB
Interrupteurs de sécurité avec boîtier plastique	100677	11-03/18		6.6 MB
Interruptores de seguridad con carcasa plástica	104855	11-03/18		6.6 MB
Bezpečnostní spínače s plastovým pouzdrém	121649	11-03/18		6.6 MB
Safety Switches with Plastic Housing	096956	11-03/18		6.6 MB
塑料壳体的安全开关	116243	11-03/18		6.2 MB

- Sicherheitsschalter mit Metallgehäuse Safety Switches with Metal Housing Bezpečnostní spínače s kovovým pouzdrém Interrupteurs de sécurité avec boîtier métallique 金属壳体的安全开关 Interruptores de seguridad con carcasa metálica

	<b>Doc. no.</b>	<b>Version</b>	<b>Language</b>	<b>Download</b>
Sicherheitsschalter mit Metallgehäuse	100319	11-03/18		 7.9 MB
Interrupteurs de sécurité avec boîtier métallique	100676	11-03/18		 7.9 MB
Interruptores de seguridad con carcasa metálica	104856	11-03/18		 14.0 MB
Safety Switches with Metal Housing	100369	11-03/18		 7.9 MB
Bezpečnostní spínače s kovovým pouzdem	121650	11-03/18		 7.9 MB
金属壳体 的安全开关	102453	11-03/18		 8.2 MB