

ITEM 103714 NOTENTSPERRUNG CET

Description	Technical data	Accessories	Downloads
-------------	----------------	-------------	-----------

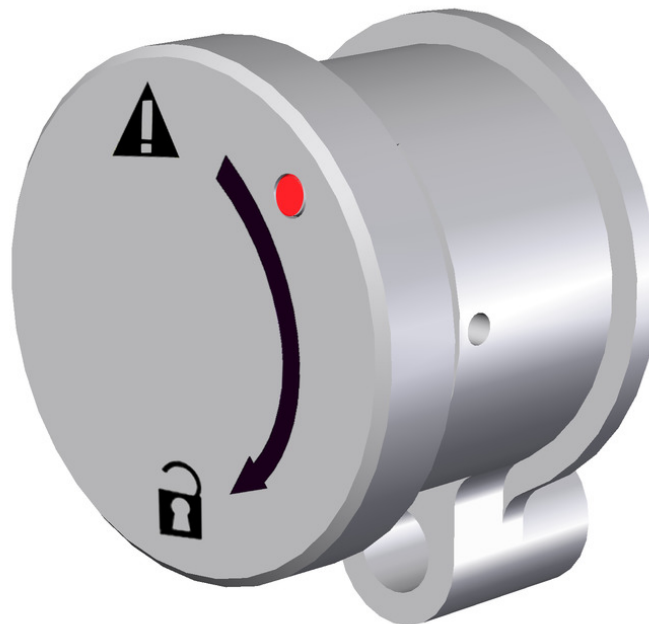

Using the emergency unlocking the read head/switch can be unlocked manually. In the locked position of the emergency unlocking, a ball detent mechanism prevents unintentional unlocking of the read head due to vibration or similar. In the unlocked position of the emergency unlocking, an integrated bolt engages in a bore on the flange. To reset the emergency unlocking, first the bolt must be pressed inwards, out of the detent mechanism, using a tool. Lead seal kit included.

Mechanical values and environment

Material	Aluminum
----------	----------

Miscellaneous

Detent mechanism	Yes
------------------	-----

Dimension drawing

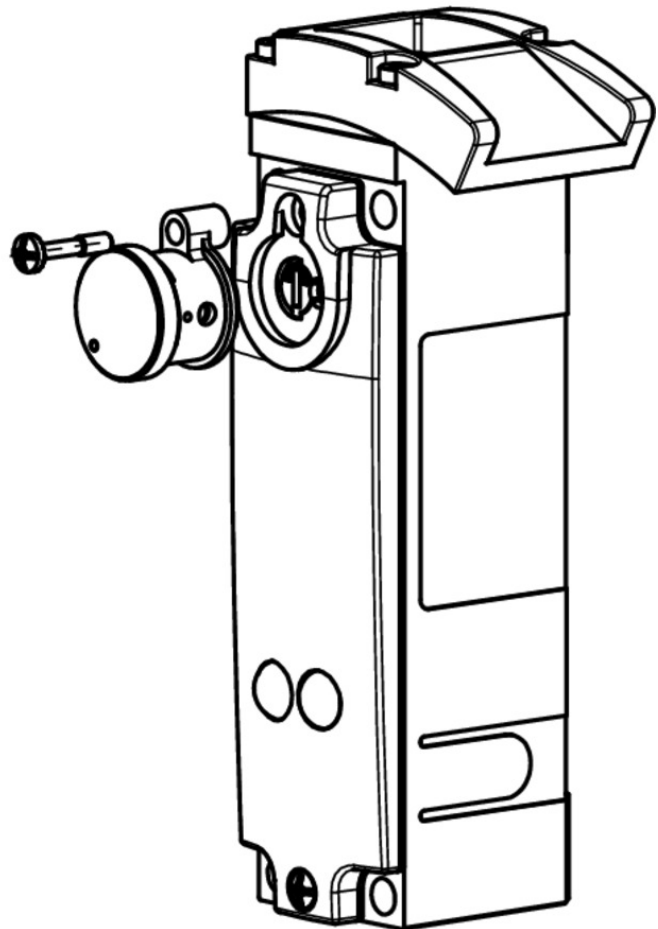
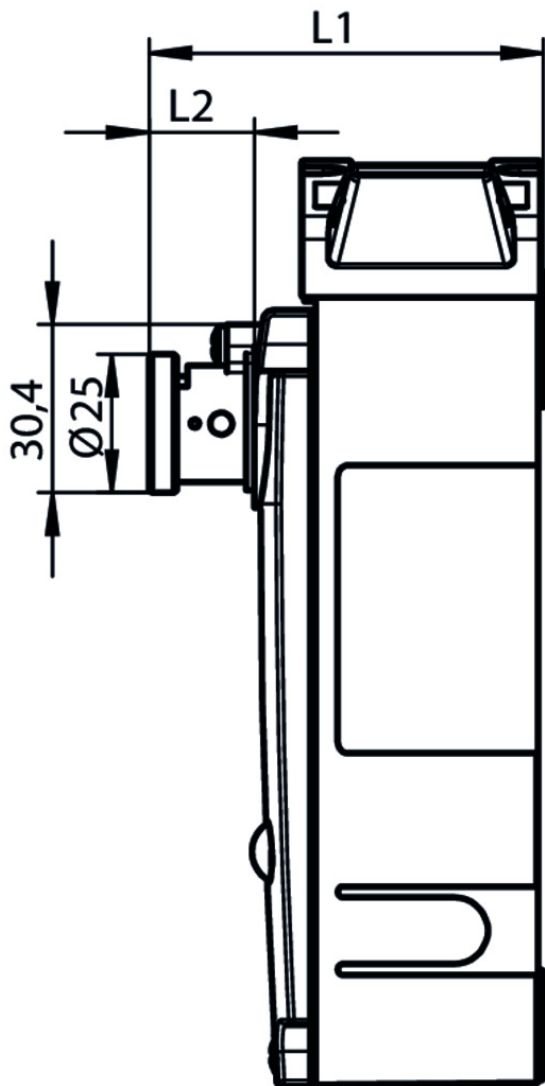

Spare parts

- Lead seal kit

087256 PLOMBENSATZ C1937









Catalogs

- Transpondercodierte Sicherheitsschalter - Verriegelungseinrichtungen und Zuhaltungen
Transponder-coded safety switches - Interlocking devices and guard locking devices
Interruptores de seguridad con codificación por transponder - Dispositivos de enclavamiento y bloqueos
Interrupteurs de sécurité à codage par transpondeur - Dispositifs de verrouillage et interverrouillages

Doc. no. Version Language Download

Transpondercodierte Sicherheitsschalter - Verriegelungseinrichtungen und Zuhaltungen	127594	02-01/18		 5.2 MB
Interrupteurs de sécurité à codage par transpondeur - Dispositifs de verrouillage et interverrouillages	137558	02-01/18		 5.2 MB
Interruptores de seguridad con codificación por transponder - Dispositivos de enclavamiento y bloqueos	137560	02-01/18		 5.2 MB
Transponder-coded safety switches - Interlocking devices and guard locking devices	127595	02-01/18		 5.1 MB

Transpondercodierte Sicherheitssysteme mit externer Auswertung Transponder-coded safety systems with external evaluation Sistemas de seguridad con codificación por transponder y evaluación externa Systèmes de sécurité à codage par transpondeur avec analyse externe

	Doc. no.	Version	Language	Download
Transpondercodierte Sicherheitssysteme mit externer Auswertung	127596	02-01/18		 3.1 MB
Systèmes de sécurité à codage par transpondeur avec analyse externe	137968	02-01/18		 3.0 MB
Sistemas de seguridad con codificación por transponder y evaluación externa	139969	02-01/18		 3.0 MB
Transponder-coded safety systems with external evaluation	127597	02-01/18		 3.0 MB

CAD data

CAD data for this item on TraceParts