

## ITEM 111992 EINSTELLRAD HKB 66,5 METALL SIL/SW

Description	Technical data	Accessories	Downloads
-------------	----------------	-------------	-----------



› suitable for HKB and HBA/HBM

### Mechanical values and environment

Dimensions	Ø66.5
Material	Metal

### Miscellaneous





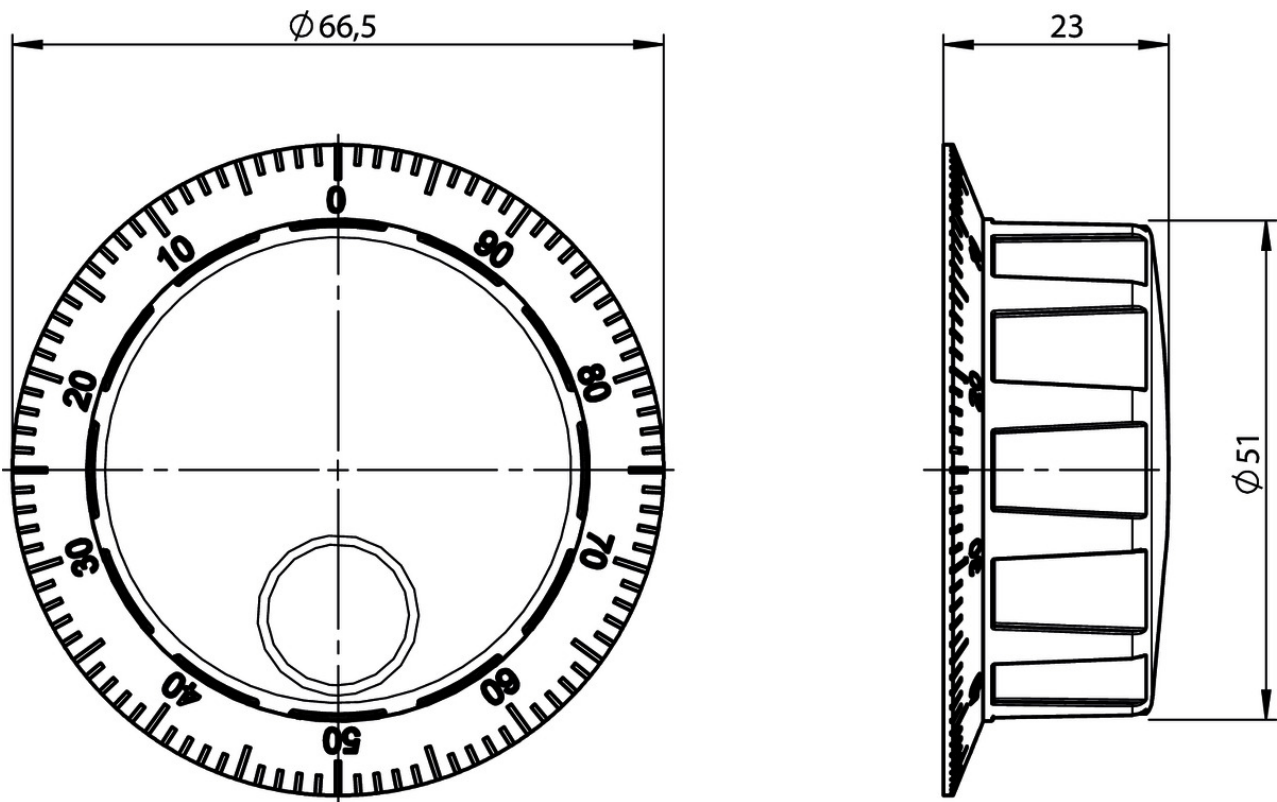

Color	silver
-------	--------

## Dimension drawing



## Catalogs

- Handbediengeräte/Handräder Hand-Held Pendant Stations/Handwheels Pupitres portables/Manivelles

	Doc. no.	Version	Language	Download
Handbediengeräte/Handräder	098619	08-09/17		 3.0 MB
Pupitres portables/Manivelles	111529	08-09/17		 3.0 MB
Hand-Held Pendant Stations/Handwheels	099443	08-09/17		 3.0 MB