

**ITEM 035613 C-M12F04-04X034PU05,0-GA-035613**

Description	Technical data	Accessories	Downloads
-------------	----------------	-------------	-----------



**Features**

- › M12 female plug, 4-pin
- › Straight plug connector
- › PUR cable
- › Halogen-free
- › Cable length 5 m
- › With flying lead
- › Cores color-coded

**Mechanical values and environment**

Sheath material	PUR
Drag chain suitability	Yes
Ambient temperature	
	static -25 ... +80 °C
	Dynamic -25 ... +80 °C
Number of conductors	4
Type of cable	straight
Cable length	5 m

Cable diameter	Approx.	4,7 mm
Conductor cross-section		0.34 mm <sup>2</sup>
Bending radius	static	5 x cable diameter
	Dynamic	10 x cable diameter
<b>Connection 1</b>		
Degree of protection		IP67 [1]
Plug lock material		CuZn
Connection		Plug connectors M12x1
Connection type		Socket
Cable outlet		straight
Number of pins		4
Plug lock		Screw connection
Plug housing material		TPU
<b>Connection 2</b>		
Conductor end		Trimmed smooth
Connection		Flying lead

### Electrical connection ratings

Rated voltage		250 V
Test voltage		2 kV [2]
<b>Connection 1</b>		
Degree of contamination according to EN 60664-1		3

[1] Only in the screwed tight state with the relating mating components

[2] eff./60s

**Dimension drawing**

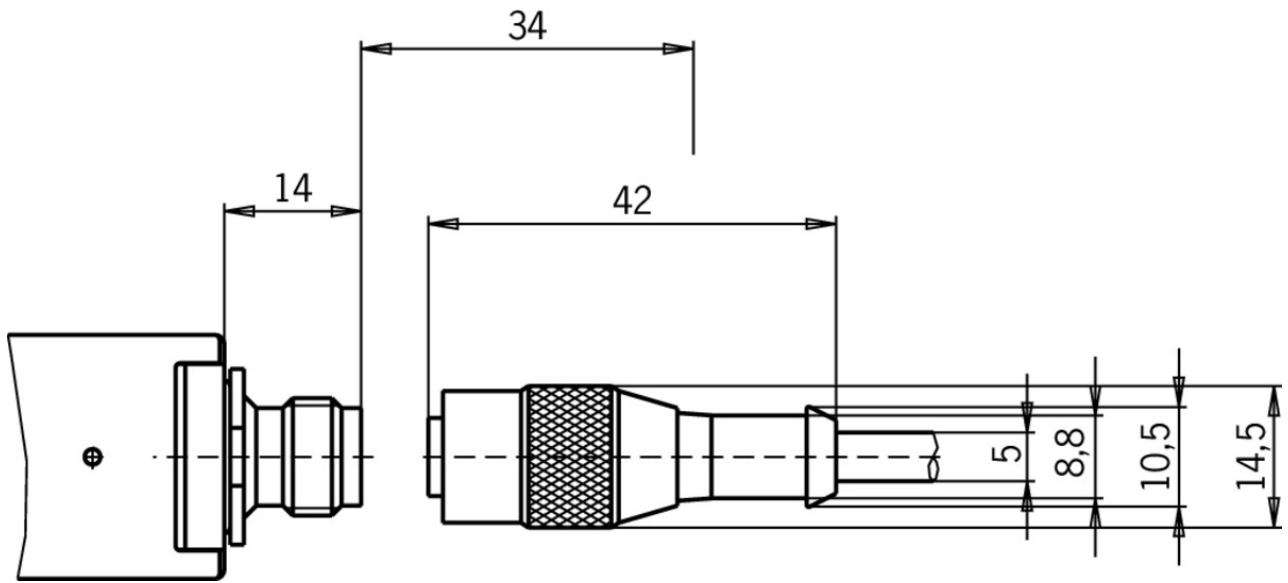



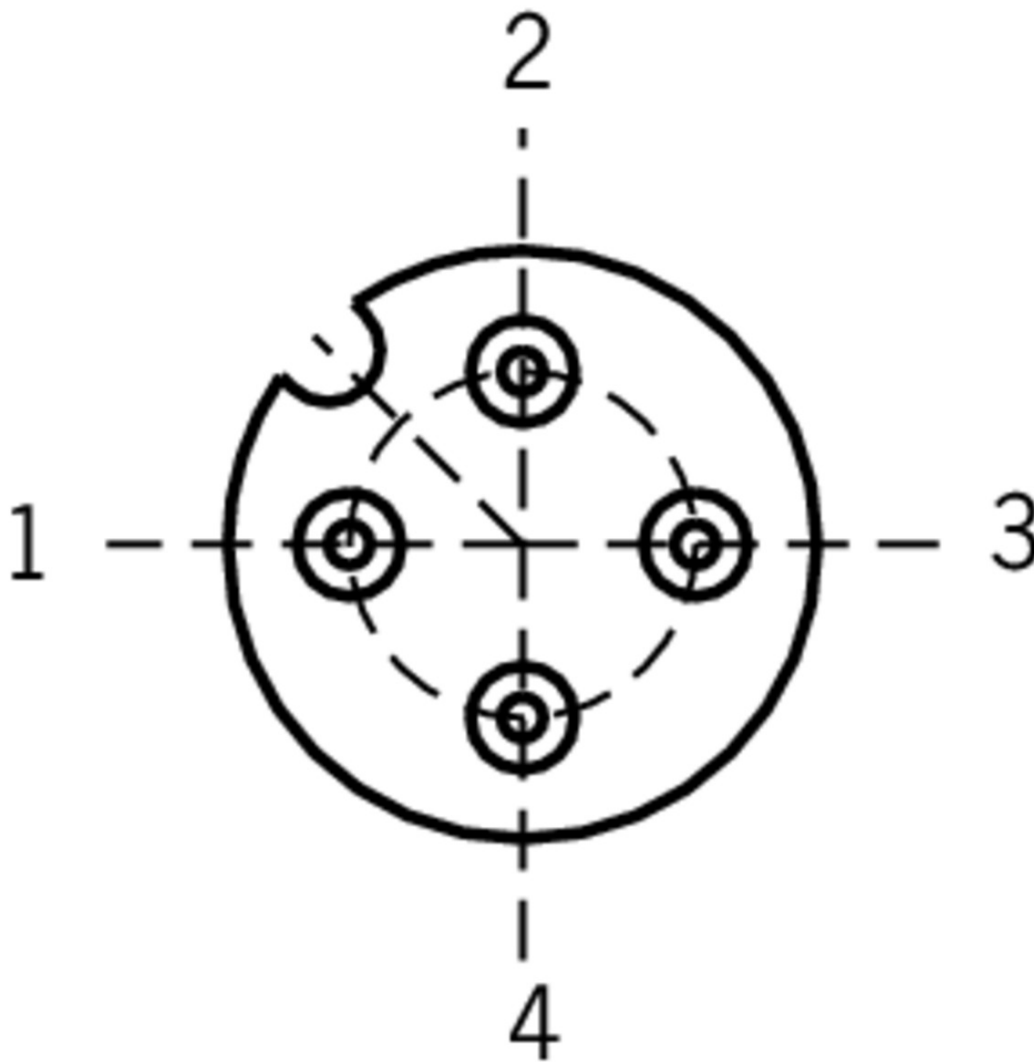



**Wiring diagram (view of connection side)**















## Catalogs

☑ Positionsschalter und Reihengrenztaster Position Switches and Multiple Limit Switches  
Interrupteurs de position et boîtiers multipistes

	Doc. no.	Version	Language	Download
Positionsschalter und Reihengrenztaster	157835	01-03/18		 4.1 MB
Interrupteurs de position et boîtiers multipistes	157837	01-03/18		 4.1 MB
Position Switches and Multiple Limit Switches	157836	01-03/18		 4.1 MB

☑ Bezpečnostní spínače s plastovým pouzdrém Sicherheitsschalter mit Kunststoffgehäuse Safety Switches with Plastic Housing Interruptores de seguridad con carcasa plástica Interrupteurs de sécurité avec boîtier plastique 塑料壳体 的安全开关

	Doc. no.	Version	Language	Download
Sicherheitsschalter mit Kunststoffgehäuse	096955	11-03/18		 6.6 MB
Interrupteurs de sécurité avec boîtier plastique	100677	11-03/18		 6.6 MB
Interruptores de seguridad con carcasa plástica	104855	11-03/18		 6.6 MB
Bezpečnostní spínače s plastovým pouzdrém	121649	11-03/18		 6.6 MB
Safety Switches with Plastic Housing	096956	11-03/18		 6.6 MB
塑料壳体 的安全开关	116243	11-03/18		 6.2 MB