

ITEM 073461 C-M12F05-05X050PU05,0-GA-073461

Description	Technical data	Accessories	Downloads
-------------	----------------	-------------	-----------



Features

- › M12 female plug, 4-pin + PE
- › Straight plug connector
- › PUR cable
- › Halogen-free
- › Cable length 5 m
- › With flying lead
- › Cores color-coded

Mechanical values and environment

Sheath material	PUR
Drag chain suitability	Yes
Ambient temperature	
static	-25 ... +80 °C
Dynamic	-25 ... +80 °C
Number of conductors	5
Type of cable	straight
Cable length	5 m

Cable diameter	Approx.	6 mm
Conductor cross-section		0.50 mm ²
Bending radius	static	5 x cable diameter
	Dynamic	10 x cable diameter
Connection 1		
Degree of protection		IP67 [1]
Plug lock material		CuZn
Connection		Plug connectors M12x1
Connection type		Socket
Cable outlet		straight
Number of pins		5
Plug lock		Screw connection
Plug housing material		TPU
Connection 2		
Conductor end		Trimmed smooth
Connection		Flying lead

Electrical connection ratings

Rated voltage		63 V
Test voltage		1,5 kV [2]
Connection 1		
Degree of contamination according to EN 60664-1		3

[1] Only in the screwed tight state with the relating mating components

[2] eff./60s

Dimension drawing

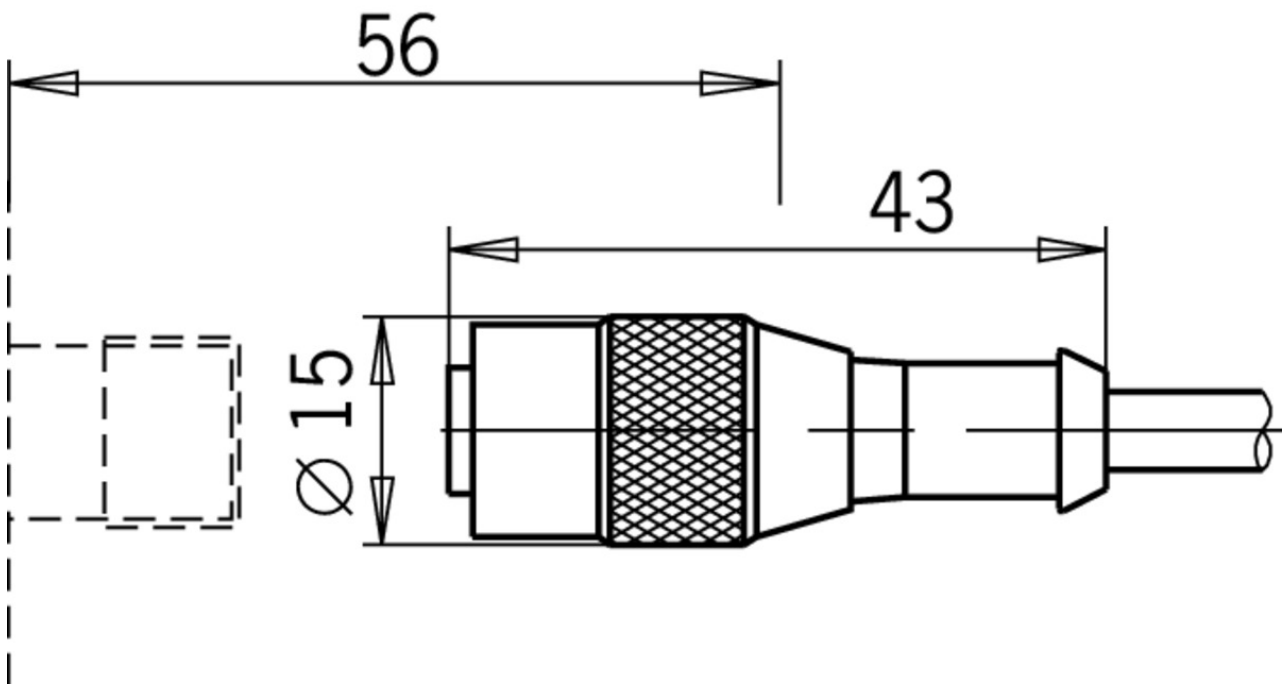



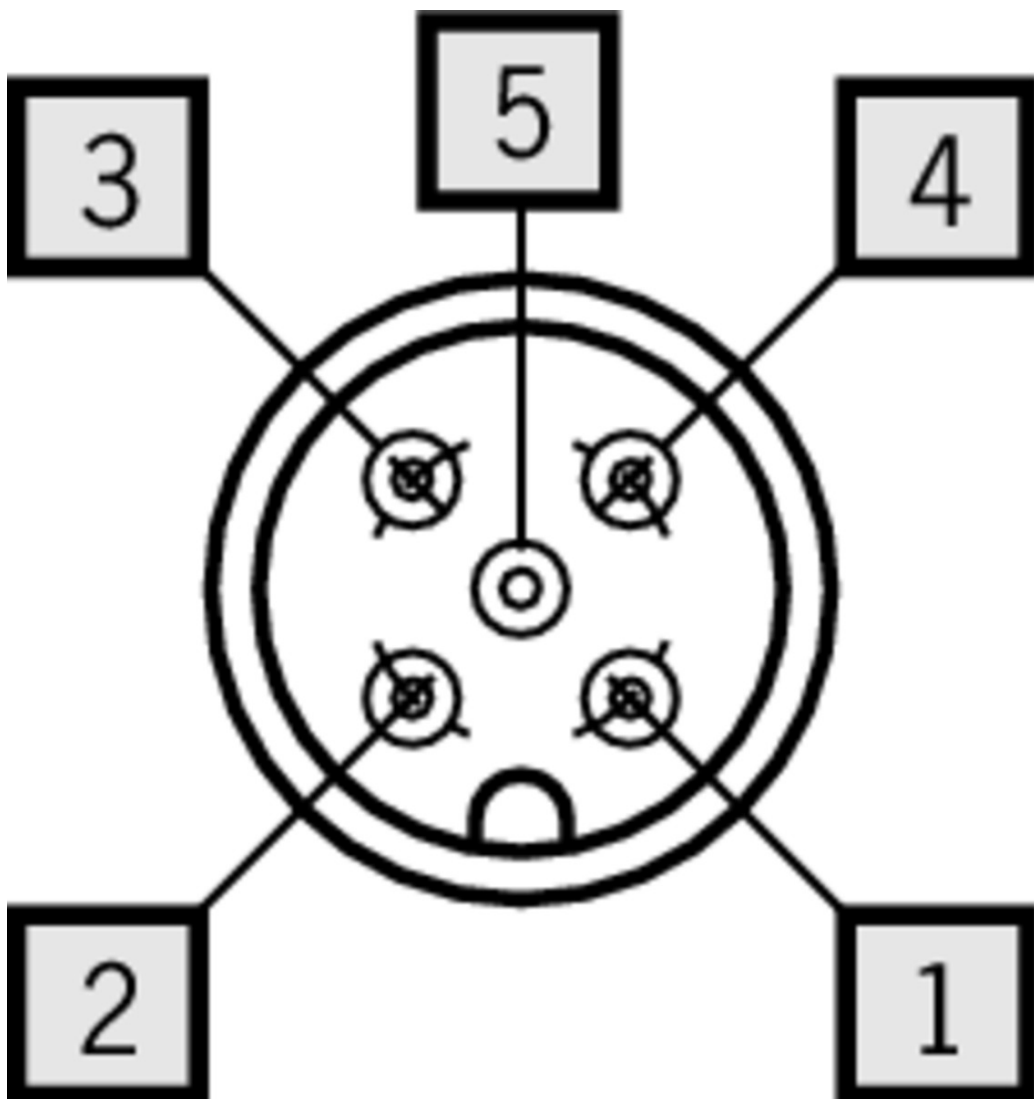



View of connection side



Catalogs

- ✓ Positionsschalter und Reihengrenztaster Position Switches and Multiple Limit Switches
Interrupteurs de position et boîtiers multipistes

	Doc. no.	Version	Language	Download
Positionsschalter und Reihengrenztaster	157835	01-03/18		 4.1 MB
Interrupteurs de position et boîtiers multipistes	157837	01-03/18		 4.1 MB
Position Switches and Multiple Limit Switches	157836	01-03/18		 4.1 MB