

ITEM 100177 C-M12F08-08X025PV05,0-MA-100177

Description	Technical data	Accessories	Downloads
-------------	----------------	-------------	-----------

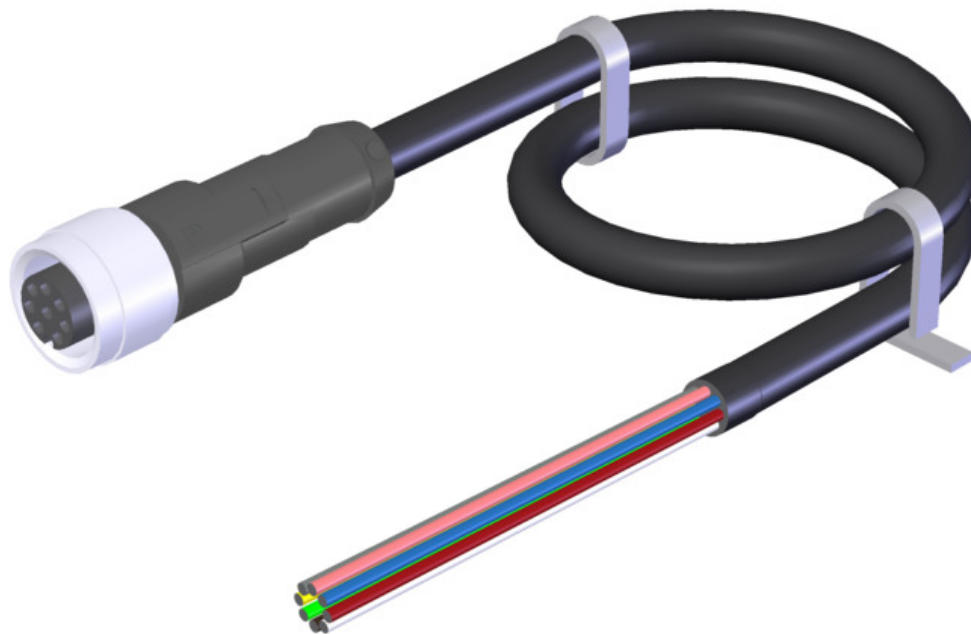

Features

- › M12 female plug, 8-pin
- › Straight plug connector
- › PVC cable
- › Cable length 5 m
- › With flying lead

Terminal assignment

View of connection side	Pin	Conductor coloring
	1	WH
	2	BN
	3	GN
	4	YE
	5	GY
	6	PK
	7	BU
	8	RD

Mechanical values and environment

Sheath material	PVC
Conductor insulation material	PVC
Conductor material	Cu flexible wire bare
Fire behavior	Flame retardant according to UL-Style 2464
Drag chain suitability	No
UV resistance	Moderately UV-resistant
Ambient temperature	
static	-25 ... +80 °C
Dynamic	-5 ... +80 °C
Number of conductors	8
Type of cable	straight
Cable length	5 m
Cable diameter	
Approx.	5,9 mm
Conductor cross-section	0.25 mm ²
Conductor identification	Color code
Sheath color	Black
Bending radius	
static	5 x cable diameter
Dynamic	15 x cable diameter
	Connection 1
Degree of protection	IP67 [1]
Plug lock material	CuZn, nickel-plated
Insertion cycles	100
Insulating material group	1
Connection	Plug connectors M12x1
Connection type	Socket
Cable outlet	straight
Number of pins	8
Plug lock	Screw connection
Plug housing material	TPU
	Connection 2
Conductor end	Sheath stripped
Connection	Flying lead

Electrical connection ratings

Nominal current	
At 25° C	2 A
Rated voltage	30 V

Overvoltage category according to IEC EN 60664-1	III
Rated surge voltage according to IEC 60664-1	800 V
Specific cable resistance	78 Ω /km
Specific inductance	0,51 mH/km
Specific capacitance	107 nF/km
	Connection 1
Degree of contamination according to EN 60664-1	3

[1] In the inserted state

Dimension drawing

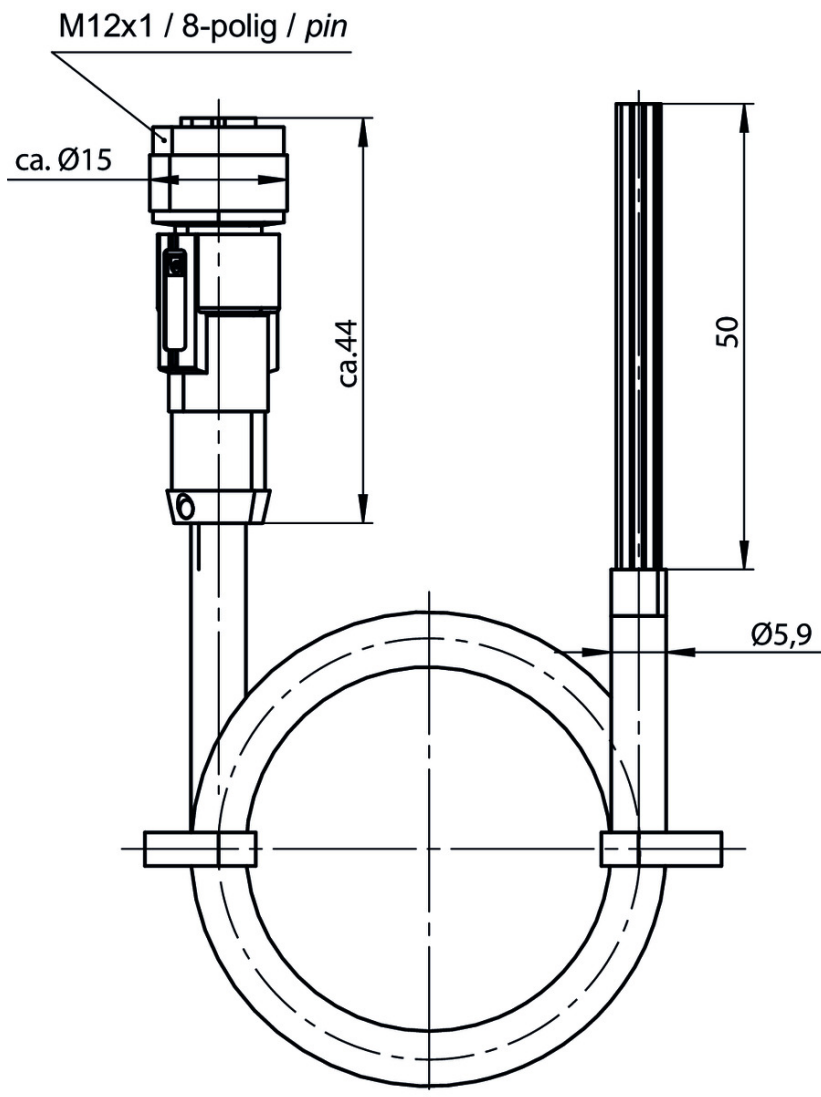

Terminal assignment

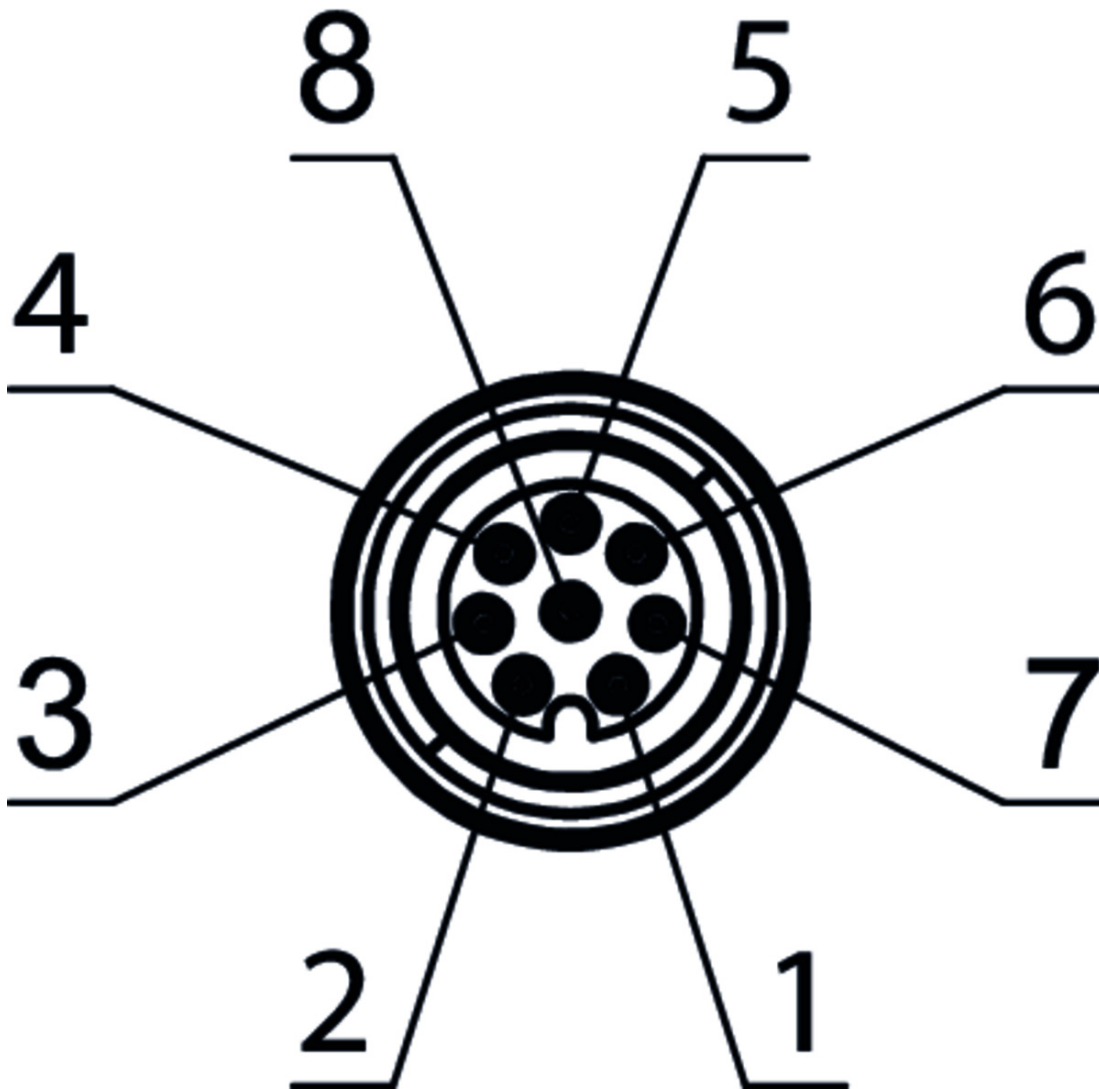









Catalogs

- ✓ Light grids and light curtains LCA Barreras fotoeléctricas y cortinas fotoeléctricas LCA Barrières photoélectriques et rideaux lumineux LCA Lichtgitter und Lichtvorhänge LCA

	Doc. no.	Version	Language	Download
Lichtgitter und Lichtvorhänge LCA	157084	03-03/18		2.5 MB
Barrières photoélectriques et rideaux lumineux LCA	157086	03-03/18		2.5 MB
Barreras fotoeléctricas y cortinas fotoeléctricas LCA	157087	03-03/18		2.5 MB
Light grids and light curtains LCA	157085	03-03/18		2.5 MB

- ✓ Transpondercodierte Sicherheitsschalter - Verriegelungseinrichtungen und Zuhaltungen
Transponder-coded safety switches - Interlocking devices and guard locking devices
Interruptores de seguridad con codificación por transponder - Dispositivos de enclavamiento y bloqueos
Interrupteurs de sécurité à codage par transpondeur - Dispositifs de verrouillage et interverrouillages

	Doc. no.	Version	Language	Download
Transpondercodierte Sicherheitsschalter - Verriegelungseinrichtungen und Zuhaltungen	127594	02-01/18		 5.2 MB
Interrupteurs de sécurité à codage par transpondeur - Dispositifs de verrouillage et interverrouillages	137558	02-01/18		 5.2 MB
Interruptores de seguridad con codificación por transponder - Dispositivos de enclavamiento y bloqueos	137560	02-01/18		 5.2 MB
Transponder-coded safety switches - Interlocking devices and guard locking devices	127595	02-01/18		 5.1 MB