

ITEM 102490 C-M23F19-19XDIFPU40,0-MA-102490

Description	Technical data	Accessories	Downloads
-------------	----------------	-------------	-----------



Features

- › M23 plug connector, 18-pin + PE
- › Straight plug connector
- › PUR cable
- › Cable length 40 m
- › With flying lead
- › Cores color-coded

Connector assignment

Plug connector (view of connection side)	Pin	Cross-section	Conductor coloring
	1	0.5 ²	VT
	2	0.5 ²	RD
	3	0.5 ²	GY
	4	0.5 ²	RDBU
	5	0.5 ²	GN
	6	1.0 ²	BU

Plug connector (view of connection side)	Pin	Cross-section	Conductor coloring
	7	0.5 ²	GYPK
	8	0.5 ²	GNWH
	9	0.5 ²	YEWH
	10	0.5 ²	GYWH
	11	0.5 ²	BK
	12	1.0 ²	GNYE
	13	0.5 ²	PK
	14	0.5 ²	BNGY
	15	0.5 ²	BNYE
	16	0.5 ²	BNGN
	17	0.5 ²	WH
	18	0.5 ²	YE
	19	1.0 ²	BN

Approvals



Mechanical values and environment

Sheath material	PUR
Conductor insulation material	PP
Conductor material	Bare Cu flexible wire super fine strands
Fire behavior	Flame retardant according to DIN EN 60332-1-2
Drag chain suitability	Yes
Ambient temperature	Dynamic -20 ... +80 °C static -20 ... +80 °C
Number of conductors	19
Type of cable	straight
Cable length	40 m
Cable diameter	Approx. 10,4 mm
Conductor cross-section	16 x 0.5 mm ² / 3 x 1 mm ²
Conductor identification	Color code
Sheath color	Black
Bending radius	Dynamic 10x cable diameter
	Connection 1

Degree of protection	IP65 / IP67 [1]
Plug lock material	CuZn, nickel-plated
Designation of plug connector	RC [2]
Insertion cycles	50
Connection	Plug connector M23
Connection type	Socket
Cable outlet	straight
Number of pins	19 [3]
Plug lock	Screw connection
Plug housing material	CuZn, nickel-plated
	Connection 2
Conductor end	Sheath stripped
Connection	Flying lead

Electrical connection ratings

Rated voltage	150 V
Overtoltage category according to IEC EN 60664-1	II
Test voltage	1,5 kV
	Connection 1
Degree of contamination according to EN 60664-1	3

[1] Locked

[2] With screen bonding clamp

[3] 18+PE

Dimension drawing

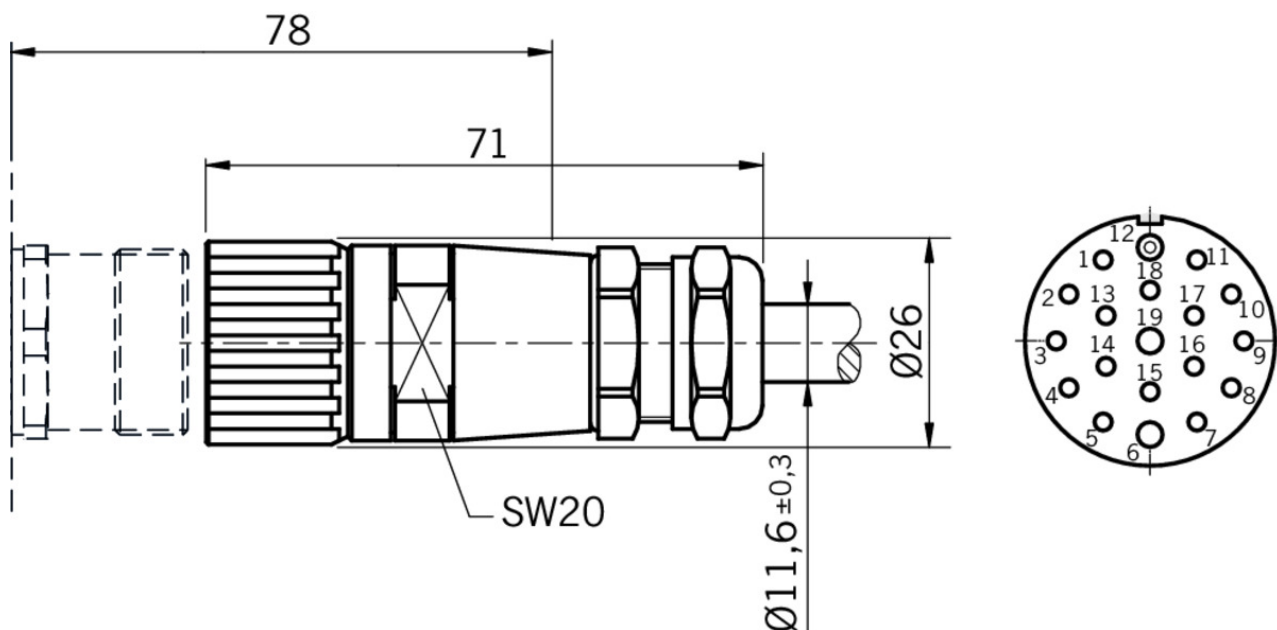

Connection material

- ✓ Coupling socket RC18, straight, with option C1825



129500 RC18EM-C1825

✓ Features

- › Coupling socket M23, straight
- › Number of pins: 19-pin with screen bonding clamp
- › Suitable for extension of plug RC18EF-1825, RC18WF-1825
- › Replacement crimp contacts available as item number 155811.

Catalogs

- ✓ Multifunctional Gate Box MGB Multifunctional Gate Box MGB Multifunctional Gate Box MGB Multifunctional Gate Box MGB 多功能系统安全控制系统 MGB













	Doc. no.	Version	Language	Download
Multifunctional Gate Box MGB	106108	10-02/18		8.2 MB
Multifunctional Gate Box MGB	109155	10-02/18		8.2 MB
Multifunctional Gate Box MGB	114433	10-02/18		8.3 MB
Multifunctional Gate Box MGB	121652	10-02/18		8.0 MB
Multifunctional Gate Box MGB	106109	10-02/18		8.2 MB
多功能系统安全控制系统 MGB	155883	10-02/18		8.3 MB

- ✓ Transpondercodierte Sicherheitsschalter - Verriegelungseinrichtungen und Zuhaltungen
Transponder-coded safety switches - Interlocking devices and guard locking devices
Interruptores de seguridad con codificación por transponder - Dispositivos de enclavamiento y













bloqueos Interruptores de seguridad à codage par transpondeur - Dispositifs de verrouillage et interverrouillages

	Doc. no.	Version	Language	Download
Transpondercodierte Sicherheitsschalter - Verriegelungseinrichtungen und Zuhaltungen	127594	02-01/18		 5.2 MB
Interrupteurs de sécurité à codage par transpondeur - Dispositifs de verrouillage et interverrouillages	137558	02-01/18		 5.2 MB
Interruptores de seguridad con codificación por transponder - Dispositivos de enclavamiento y bloqueos	137560	02-01/18		 5.2 MB
Transponder-coded safety switches - Interlocking devices and guard locking devices	127595	02-01/18		 5.1 MB

 Bezpečnostní spínače s plastovým pouzdrém Sicherheitsschalter mit Kunststoffgehäuse Safety Switches with Plastic Housing Interruptores de seguridad con carcasa plástica Interrupteurs de sécurité avec boîtier plastique 塑料壳体 的安全开关

	Doc. no.	Version	Language	Download
Sicherheitsschalter mit Kunststoffgehäuse	096955	11-03/18		 6.6 MB
Interrupteurs de sécurité avec boîtier plastique	100677	11-03/18		 6.6 MB
Interruptores de seguridad con carcasa plástica	104855	11-03/18		 6.6 MB
Bezpečnostní spínače s plastovým pouzdrém	121649	11-03/18		 6.6 MB
Safety Switches with Plastic Housing	096956	11-03/18		 6.6 MB
塑料壳体 的安全开关	116243	11-03/18		 6.2 MB

 Sicherheitsschalter mit Metallgehäuse Safety Switches with Metal Housing Bezpečnostní spínače s kovovým pouzdrém Interrupteurs de sécurité avec boîtier métallique 金属壳体 的安全开关 Interruptores de seguridad con carcasa metálica

	Doc. no.	Version	Language	Download
Sicherheitsschalter mit Metallgehäuse	100319	11-03/18		 7.9 MB
Interrupteurs de sécurité avec boîtier métallique	100676	11-03/18		 7.9 MB
Interruptores de seguridad con carcasa metálica	104856	11-03/18		 14.0 MB
Safety Switches with Metal Housing	100369	11-03/18		 7.9 MB
Bezpečnostní spínače s kovovým pouzdrém	121650	11-03/18		 7.9 MB
金属壳体 的安全开关	102453	11-03/18		 8.2 MB