

ITEM 111839 MGB-H-AA1A6-L-111839

Description	Technical data	Accessories	Downloads
-------------	----------------	-------------	-----------



Features

- › Intelligent bolt tongue
- › Fold-out lockout mechanism
- › Second automatically extending lockout mechanism
- › Door handle
- › Mounting plate

Bolt tongue

The bolt tongue is reliably detected by transponder as soon as it is inserted in the evaluation module.

Lockout mechanism (automatically extending and fold-out)

For cleaning and service on the machine the bolt tongue can be locked with max. 3 padlocks.

The lockout mechanism extends automatically on the actuation of the handle and prevents the operation of the machine in the safe state. In addition, the fold-out lockout mechanism can be used.

Door handle

The MGB has a robust door handle that can be rotated in 90° steps to suit all installations. The actuating direction can be changed very easily for doors hinged on the left or right.

Door knob

As an alternative to the door handle the handle module can also be equipped with a door knob.

Approvals



Mechanical values and environment

Housing material	Reinforced plastic, die-cast zinc nickel-plated, stainless steel
Weight	Net 1,00 kg
Ambient temperature	-20 ... 55 °C
Degree of protection	IP65
Installation position	Door hinge DIN left

Miscellaneous

Additional feature	With mounting plate and automatic lockout mechanism
Product version number	V3.0.0

Dimension drawing

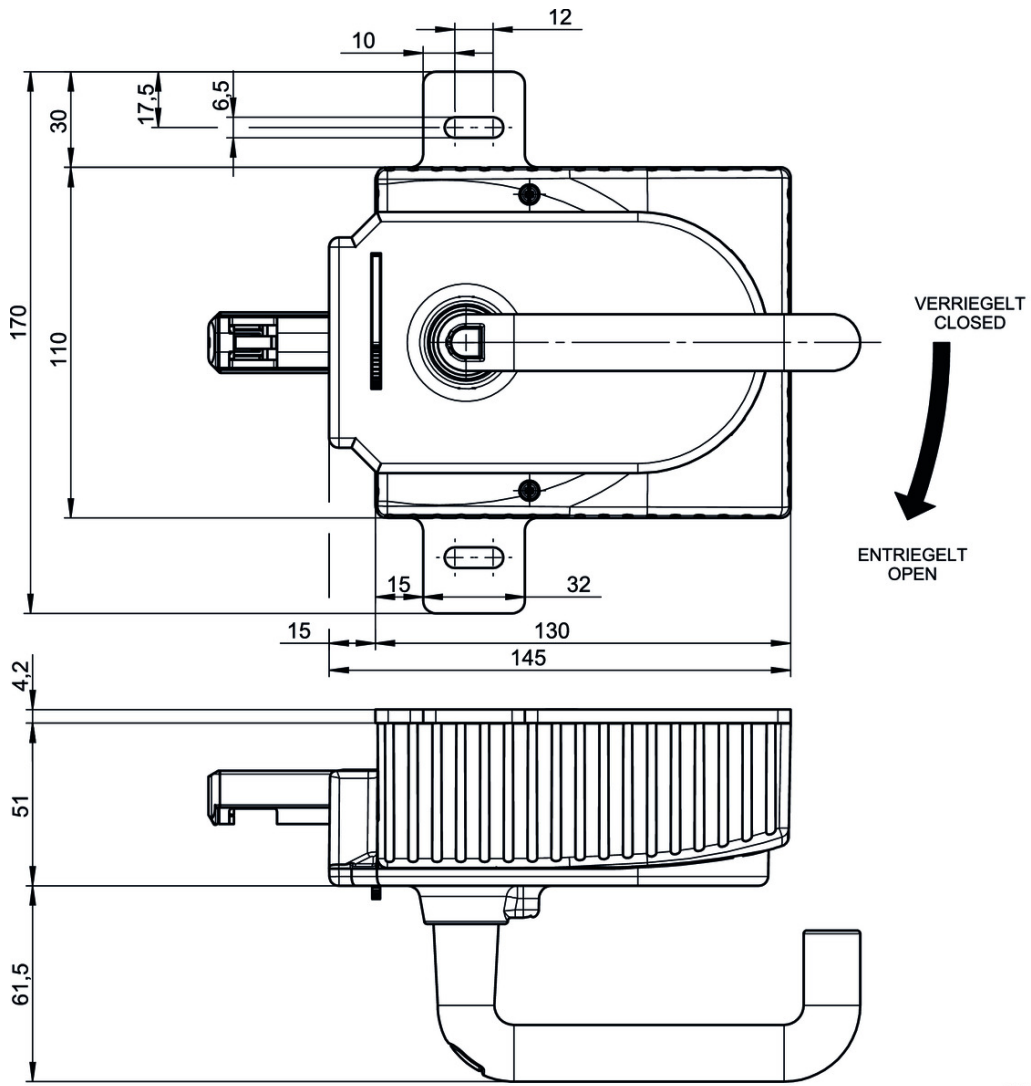

...

Dimension drawing

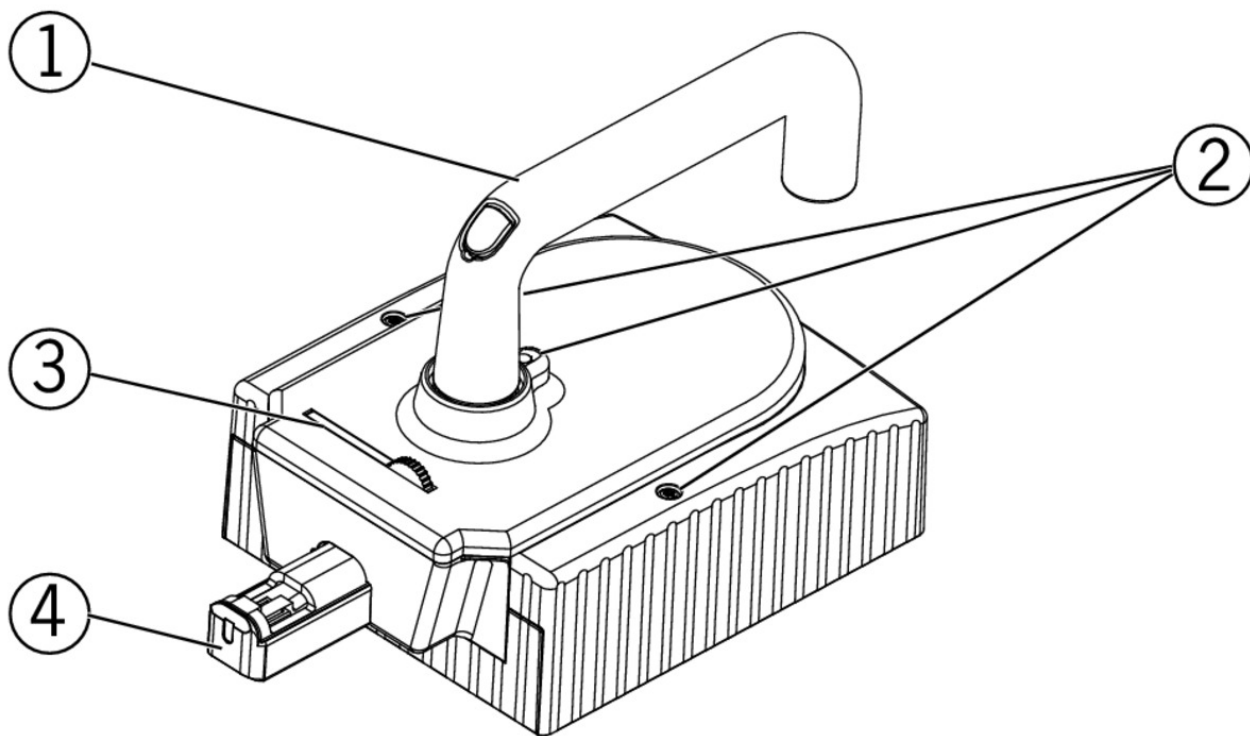

Dimension drawing

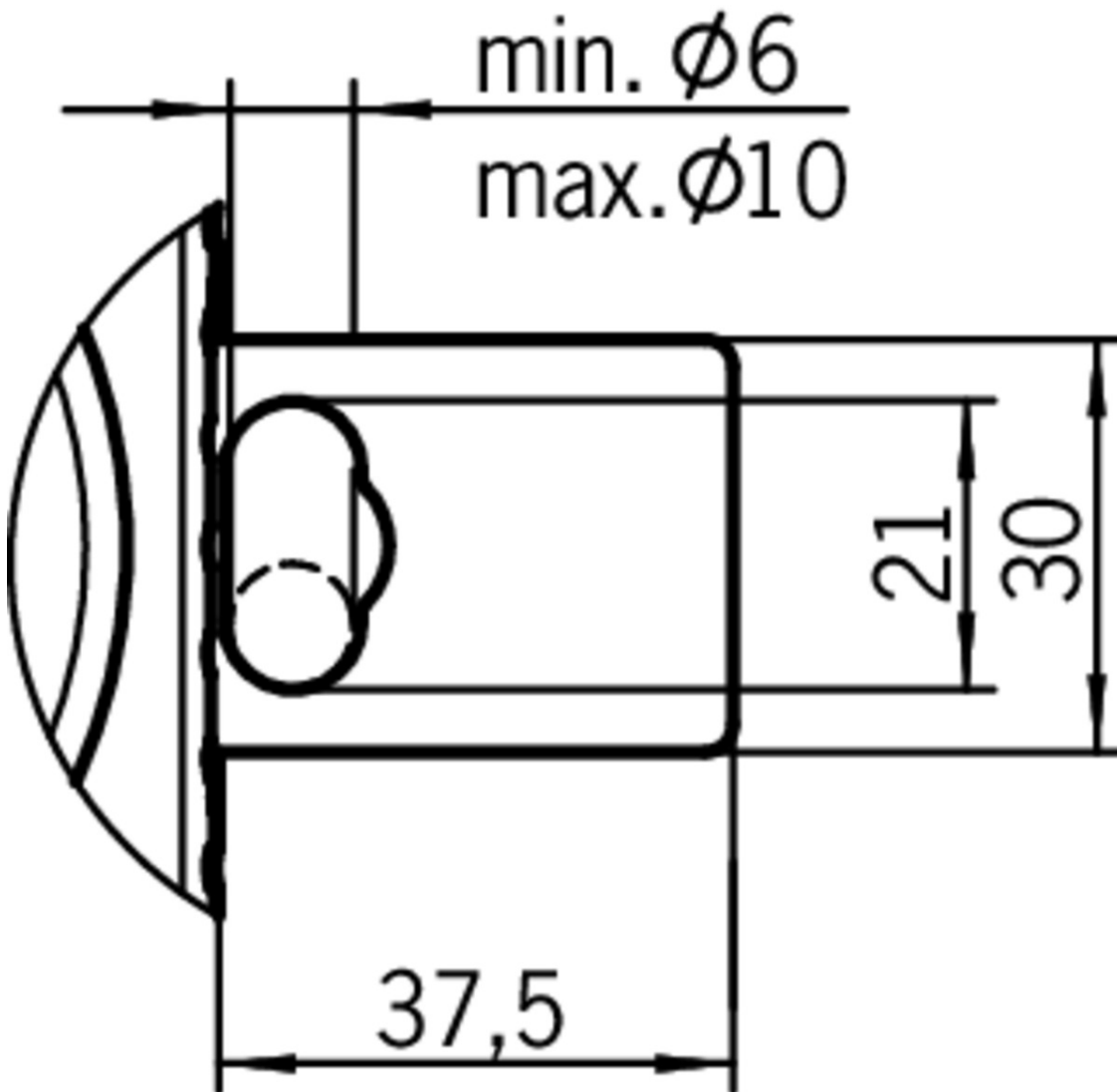

Function expansion

Door handle for MGB-H...



123926 MGB-A-DOORHANDLE-S2-123926

Features

- › Aluminum silver anodized
- › For mounting on all MGB handle modules MGB-H from V3.0.0



110277 MGB-A-DOORHANDLE-S1-110277

Features

- › Aluminum silver anodized
- › For mounting on all MGB handle modules MGB-H up to V2.0.0

Door knob for MGB-H...



124030 MGB-A-DOORKNOB-S2-124030

Features

- › Aluminum, silver anodized

- › For mounting on all MGB handle modules MGB-H... from V3.0.0
- › e.g. on sliding doors



111460 MGB-A-DOORKNOB-S1-111460

Features

- › Aluminum, silver anodized
- › For mounting on all MGB handle modules MGB-H... up to V2.0.0
- › e.g. on sliding doors

Instructions













- ▼ Sicherheitsinformation (Teil der Betriebsanleitung Sicherheitssystem MGB-AR/MGB-AP) ab V3.0.0

	Doc. no.	Version	Language	Download
Sicherheitsinformation (Teil der Betriebsanleitung Sicherheitssystem MGB-AR/MGB-AP) ab V3.0.0 Información de seguridad (parte del manual de instrucciones Sistema de seguridad MGB-AR/MGB-AP) V3.0.0 o superior Information de sécurité (partie du mode d'emploi Système de sécurité MGB-AR/MGB-AP) à partir de V3.0.0 Informazioni sulla sicurezza (Parte delle istruzioni di impiego Sistema di sicurezza MGB-AR/MGB-AP) da V3.0.0 Säkerhetsinformation (Del av instruktionsboken Säkerhetssystem MGB-AR/MGB-AP) från V3.0.0 Safety Information (Part of the Operating Instructions Safety System MGB-AR/MGB-AP) from V3.0.0	123151	01-02/15	 	0.6 MB
Veiligheidsinformatie (Deel van de handleiding Beveiligingssysteem MGB-AR/MGB-AP) vanaf V3.0.0	123151	01-02/15		0.2 MB
Informação de segurança (Parte do manual de instruções Sistema de segurança MGB-AR/MGB-AP) a partir de V3.0.0	123151	01-02/15		0.2 MB
Bezpečnostní informace (součást návodu k použití „Bezpečnostní systém MGB-AR/MGB-AP“) od V3.0.0	123151	01-02/15		0.2 MB
Informacje o bezpieczeństwie (Część instrukcji obsługi System bezpieczeństwa MGB-AR/MGB-AP) od V3.0.0	123151	01-02/15		0.2 MB
Информация о безопасности (часть инструкции по эксплуатации Предохранительная система MGB-AR/MGB-AP) с V3.0.0	123151	01-02/15		0.3 MB

Bezpečnostná informácia (časť návodu na prevádzku Bezpečnostný systém MGB-AR/MGB-AP) od V3.0.0	123151	01-02/15		 0.2 MB
Güvenlik bilgisi (İşletim kılavuzunun parçası emniyet sistemi MGB-AR/MGB-AP) V3.0.0 ve üstü	123151	01-02/15		 0.3 MB
安全信息 (安全系统 MGB-AR/MGB-AP使用说明书的组成部分) V3.0.0以上	123151	01-02/15		 0.3 MB
安全情報 MGB-AR/MGB-AP	123151	01-02/15		 0.6 MB







Catalogs

Multifunctional Gate Box MGB Multifunctional Gate Box MGB Multifunctional Gate Box MGB Multifunctional Gate Box MGB Multifunctional Gate Box MGB Multifunctional Gate Box MGB Multifunctional Gate Box MGB Multifunctional Gate Box MGB 多功能系统安全控制系统 MGB

	Doc. no.	Version	Language	Download
Multifunctional Gate Box MGB	106108	10-02/18		 8.2 MB
Multifunctional Gate Box MGB	109155	10-02/18		 8.2 MB
Multifunctional Gate Box MGB	114433	10-02/18		 8.3 MB
Multifunctional Gate Box MGB	121652	10-02/18		 8.0 MB
Multifunctional Gate Box MGB	106109	10-02/18		 8.2 MB
多功能系统安全控制系统 MGB	155883	10-02/18		 8.3 MB

Declaration of conformity

EU-Konformitätserklärung

	Doc. no.	Version	Language	Download
EU-Konformitätserklärung Declaración UE de conformidad Déclaration UE de conformité Dichiarazione di conformità EU declaration of conformity	2123150	08-01/17	    	 0.3 MB

CAD data

CAD data for this item on TraceParts