

**ITEM 115114 C-M12F08-08X025PU20,0-MA-115114**

Description	Technical data	Accessories	Downloads
-------------	----------------	-------------	-----------

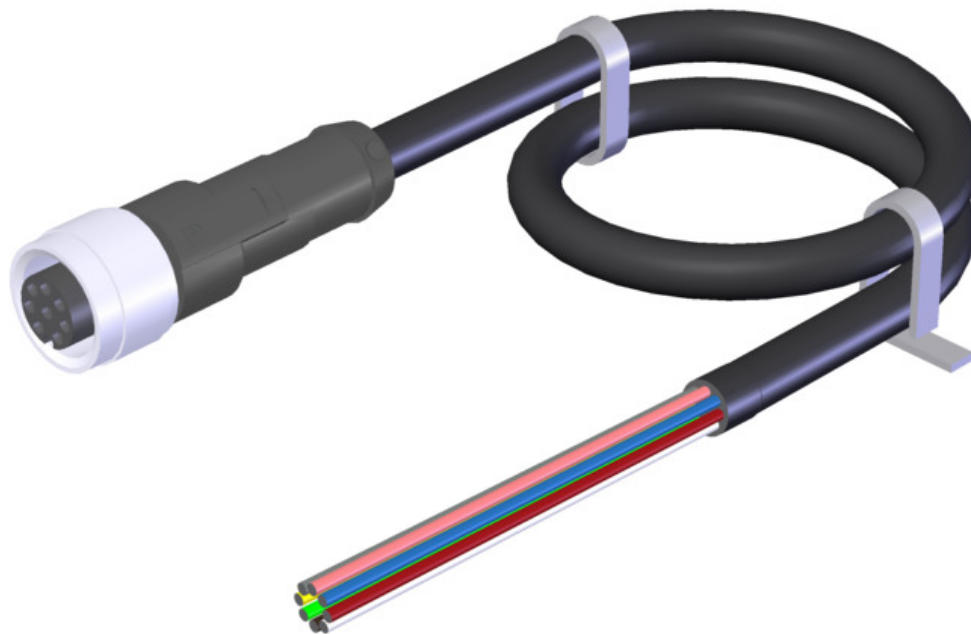

**Features**

- › M12 female plug, 8-pin
- › Straight plug connector
- › PUR cable
- › Cable length 20 m
- › With flying lead

**Terminal assignment**

View of connection side	Pin	Conductor coloring
	1	WH
	2	BN
	3	GN
	4	YE
	5	GY
	6	PK
	7	BU
	8	RD

## Mechanical values and environment

Plug lock material	CuZn/ Ni
Sheath material	PUR
Fire behavior	Flame retardant
Halogen-free	Yes <b>[1]</b>
Drag chain suitability	Yes
Ambient temperature	
static	-25 ... +80 °C
Dynamic	-25 ... +80 °C
Number of conductors	8
Type of cable	straight
Cable length	20 m
Cable diameter	
Approx.	5,9 mm
Conductor cross-section	0.25 mm <sup>2</sup>
Sheath color	Black
Bending radius	
static	8 x cable diameter
Dynamic	10 x cable diameter
	<b>Connection 1</b>
Degree of protection	IP 67 <b>[2]</b>
Insertion cycles	100
Connection	Plug connectors M12x1
Connection type	Socket
Cable outlet	straight
Number of pins	8
Plug lock	Screw connection
Plug housing material	TPU
	<b>Connection 2</b>
Conductor end	Sheath stripped
Connection	Flying lead

## Electrical connection ratings

Nominal current	
At 25° C	2 A
	<b>Connection 1</b>
Degree of contamination according to EN 60664-1	3

[1] According to DIN VDE 0472 part 815

[2] In the inserted state

### Dimension drawing

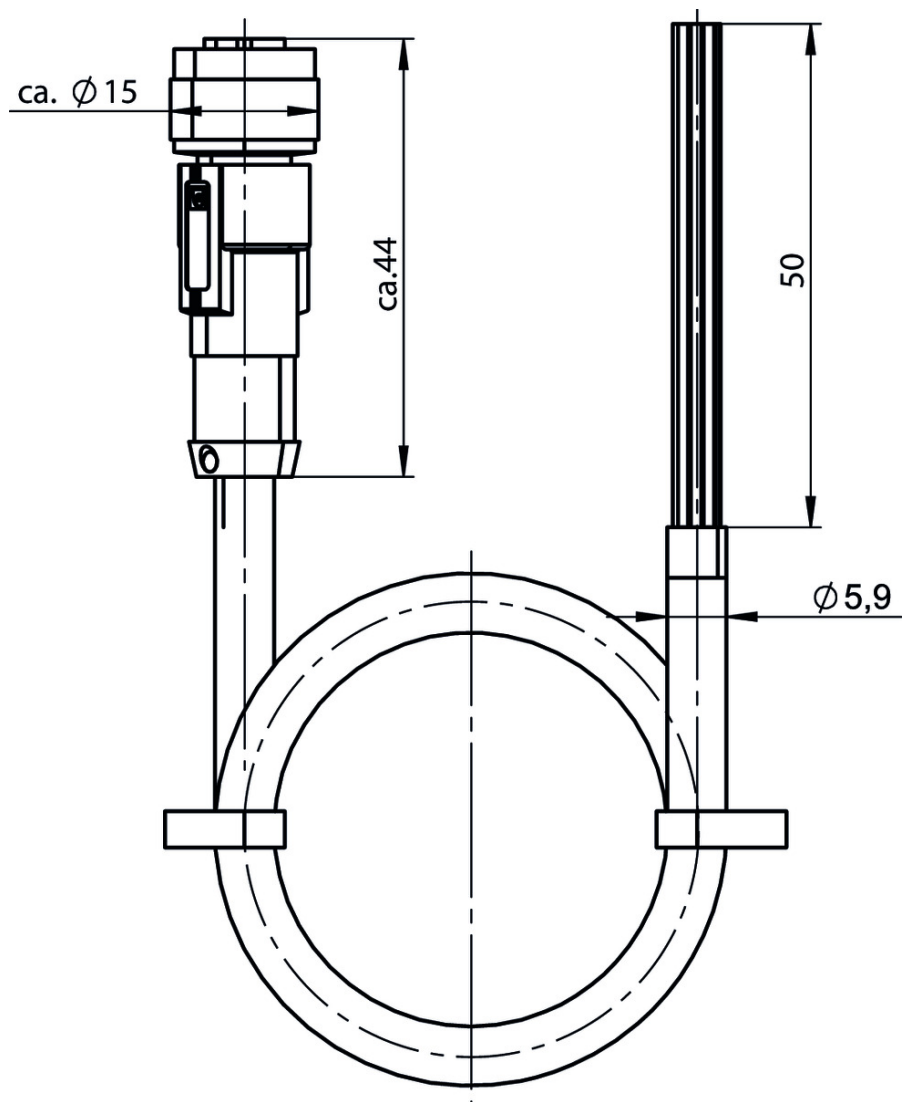

## Terminal assignment

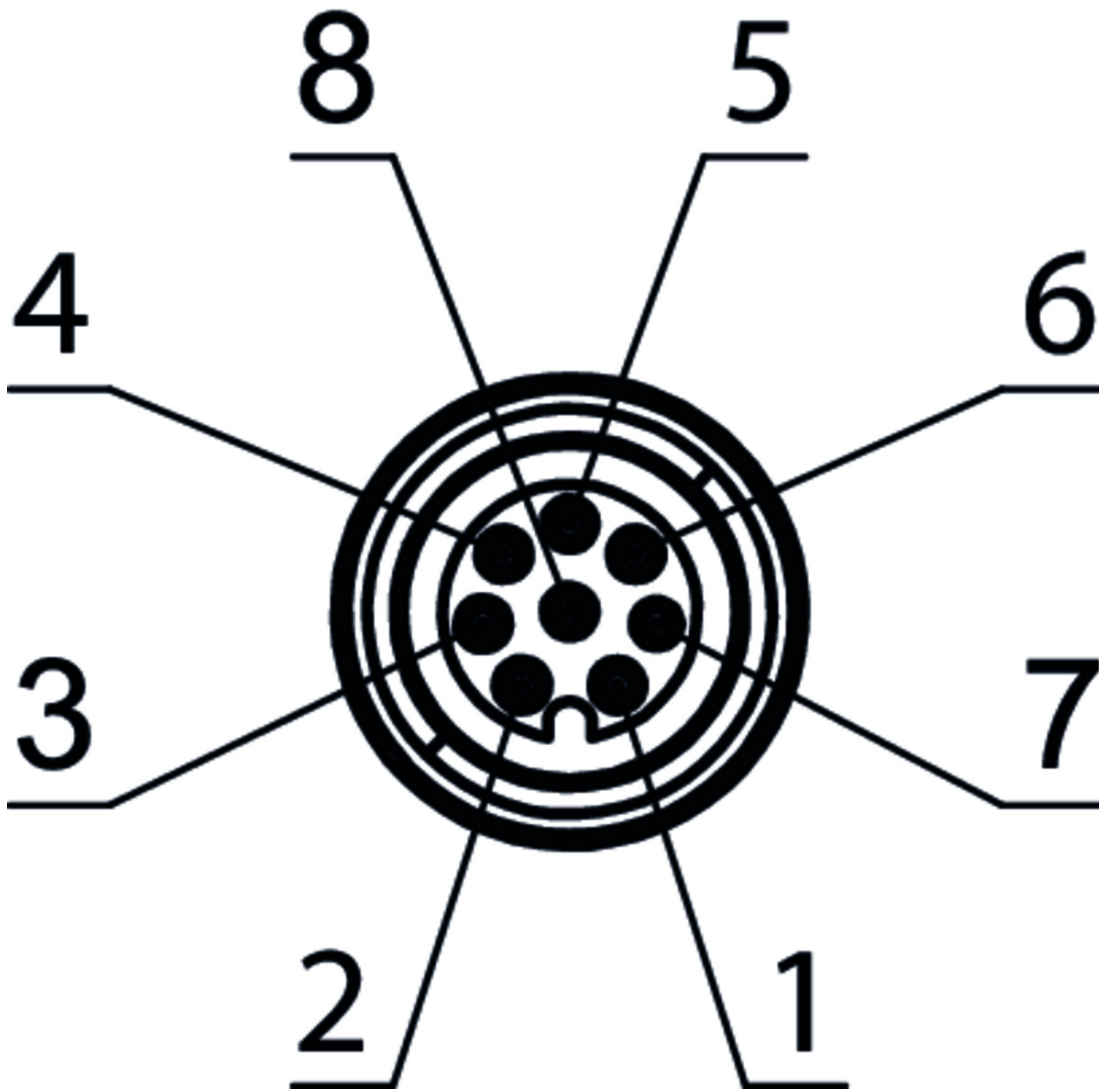

## Catalogs

- ✓ Light grids and light curtains LCA Barreras fotoeléctricas y cortinas fotoeléctricas LCA Barrières photoélectriques et rideaux lumineux LCA Lichtgitter und Lichtvorhänge LCA

	Doc. no.	Version	Language	Download
Lichtgitter und Lichtvorhänge LCA	157084	03-03/18		2.5 MB
Barrières photoélectriques et rideaux lumineux LCA	157086	03-03/18		2.5 MB
Barreras fotoeléctricas y cortinas fotoeléctricas LCA	157087	03-03/18		2.5 MB
Light grids and light curtains LCA	157085	03-03/18		2.5 MB













- ✓ Transpondercodierte Sicherheitsschalter - Verriegelungseinrichtungen und Zuhaltungen  
Transponder-coded safety switches - Interlocking devices and guard locking devices  
Interruptores de seguridad con codificación por transponder - Dispositivos de enclavamiento y bloqueos  
Interrupteurs de sécurité à codage par transpondeur - Dispositifs de verrouillage et interverrouillages

	Doc. no.	Version	Language	Download
Transpondercodierte Sicherheitsschalter - Verriegelungseinrichtungen und Zuhaltungen	127594	02-01/18		 5.2 MB
Interrupteurs de sécurité à codage par transpondeur - Dispositifs de verrouillage et interverrouillages	137558	02-01/18		 5.2 MB
Interruptores de seguridad con codificación por transponder - Dispositivos de enclavamiento y bloqueos	137560	02-01/18		 5.2 MB
Transponder-coded safety switches - Interlocking devices and guard locking devices	127595	02-01/18		 5.1 MB

 **Bezpečnostní spínače s plastovým pouzdrém Sicherheitsschalter mit Kunststoffgehäuse Safety Switches with Plastic Housing Interruptores de seguridad con carcasa plástica Interrupteurs de sécurité avec boîtier plastique 塑料壳体的安全开关**

	Doc. no.	Version	Language	Download
Sicherheitsschalter mit Kunststoffgehäuse	096955	11-03/18		 6.6 MB
Interrupteurs de sécurité avec boîtier plastique	100677	11-03/18		 6.6 MB
Interruptores de seguridad con carcasa plástica	104855	11-03/18		 6.6 MB
Bezpečnostní spínače s plastovým pouzdrém	121649	11-03/18		 6.6 MB
Safety Switches with Plastic Housing	096956	11-03/18		 6.6 MB
塑料壳体的安全开关	116243	11-03/18		 6.2 MB

 **Sicherheitsschalter mit Metallgehäuse Safety Switches with Metal Housing Bezpečnostní spínače s kovovým pouzdrém Interrupteurs de sécurité avec boîtier métallique 金属壳体的安全开关 Interruptores de seguridad con carcasa metálica**

	Doc. no.	Version	Language	Download
Sicherheitsschalter mit Metallgehäuse	100319	11-03/18		 7.9 MB
Interrupteurs de sécurité avec boîtier métallique	100676	11-03/18		 7.9 MB
Interruptores de seguridad con carcasa metálica	104856	11-03/18		 14.0 MB
Safety Switches with Metal Housing	100369	11-03/18		 7.9 MB
Bezpečnostní spínače s kovovým pouzdrém	121650	11-03/18		 7.9 MB
金属壳体的安全开关	102453	11-03/18		 8.2 MB