

ITEM 115113 C-M12F08-08X025PU10,0-MA-115113

Description	Technical data	Accessories	Downloads
-------------	----------------	-------------	-----------

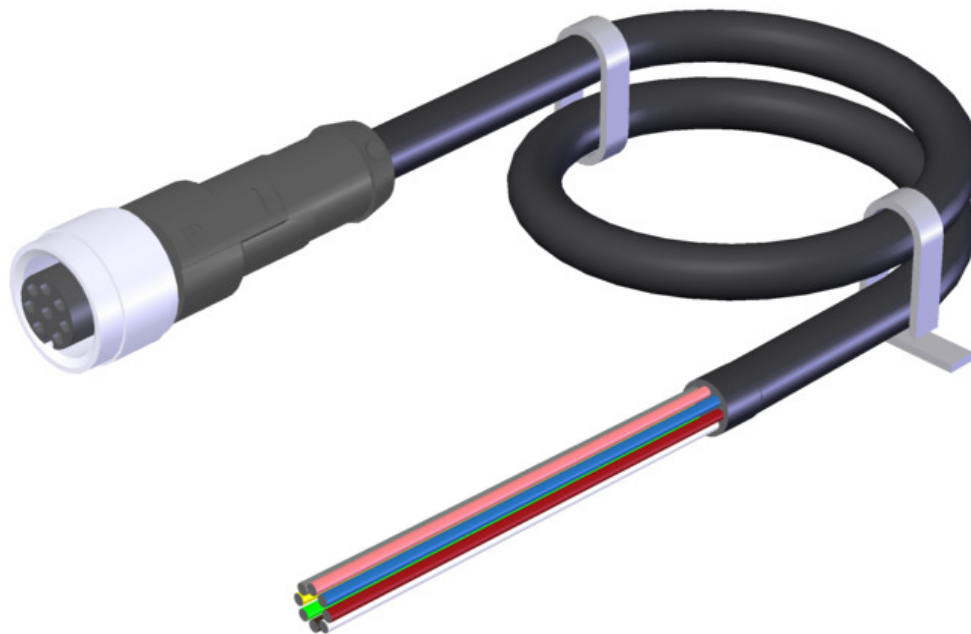

Features

- › M12 female plug, 8-pin
- › Straight plug connector
- › PUR cable
- › Cable length 10 m
- › With flying lead

Terminal assignment

View of connection side	Pin	Conductor coloring
	1	WH
	2	BN
	3	GN
	4	YE
	5	GY
	6	PK
	7	BU
	8	RD

Mechanical values and environment

Plug lock material	CuZn/ Ni
Sheath material	PUR
Fire behavior	Flame retardant
Halogen-free	Yes [1]
Drag chain suitability	Yes
Ambient temperature	static -25 ... +80 °C Dynamic -25 ... +80 °C
Number of conductors	8
Type of cable	straight
Cable length	10 m
Cable diameter	Approx. 5,9 mm
Conductor cross-section	0.25 mm ²
Sheath color	Black
Bending radius	static 8 x cable diameter Dynamic 10 x cable diameter
	Connection 1
Degree of protection	IP 67 [2]
Insertion cycles	100
Connection	Plug connectors M12x1
Connection type	Socket
Cable outlet	straight
Number of pins	8
Plug lock	Screw connection
Plug housing material	TPU
	Connection 2
Conductor end	Sheath stripped
Connection	Flying lead

Electrical connection ratings

Nominal current	At 25° C 2 A
	Connection 1
Degree of contamination according to EN 60664-1	3

[1] According to DIN VDE 0472 part 815

[2] In the inserted state

Dimension drawing

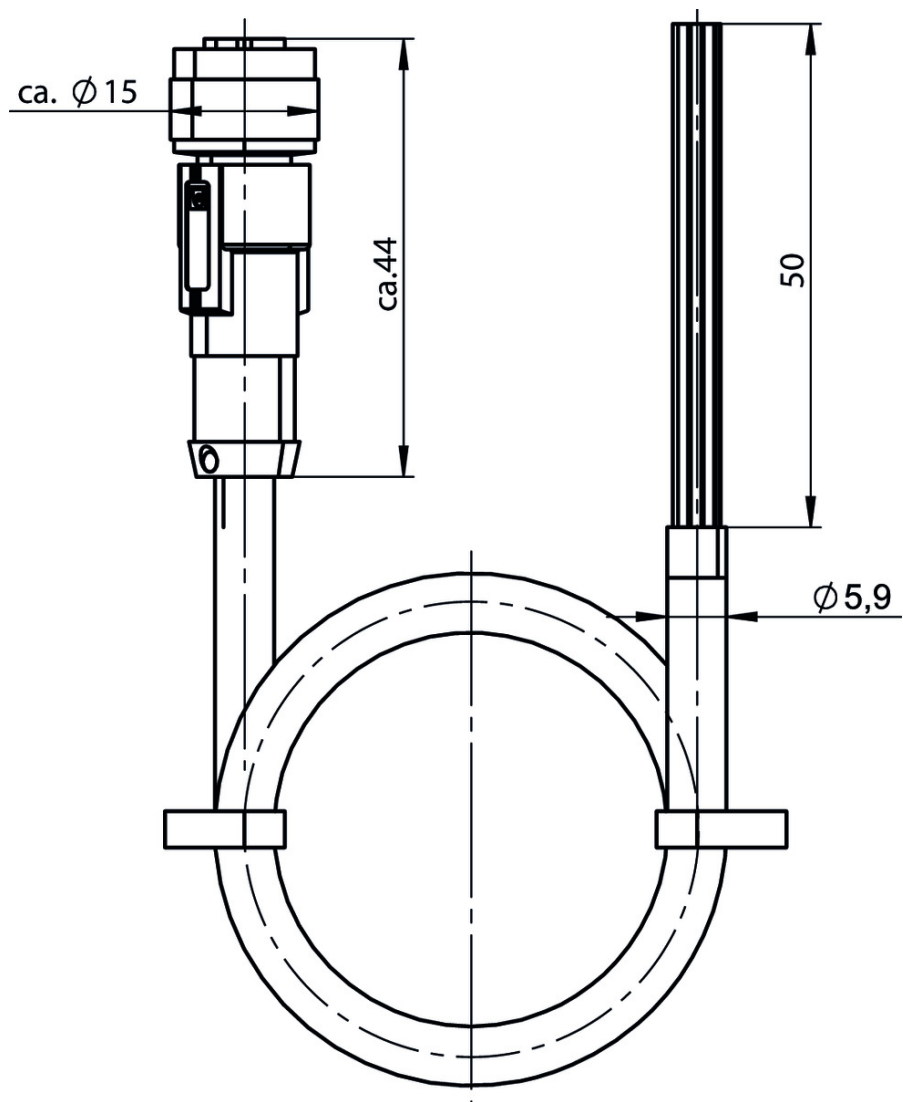

Terminal assignment

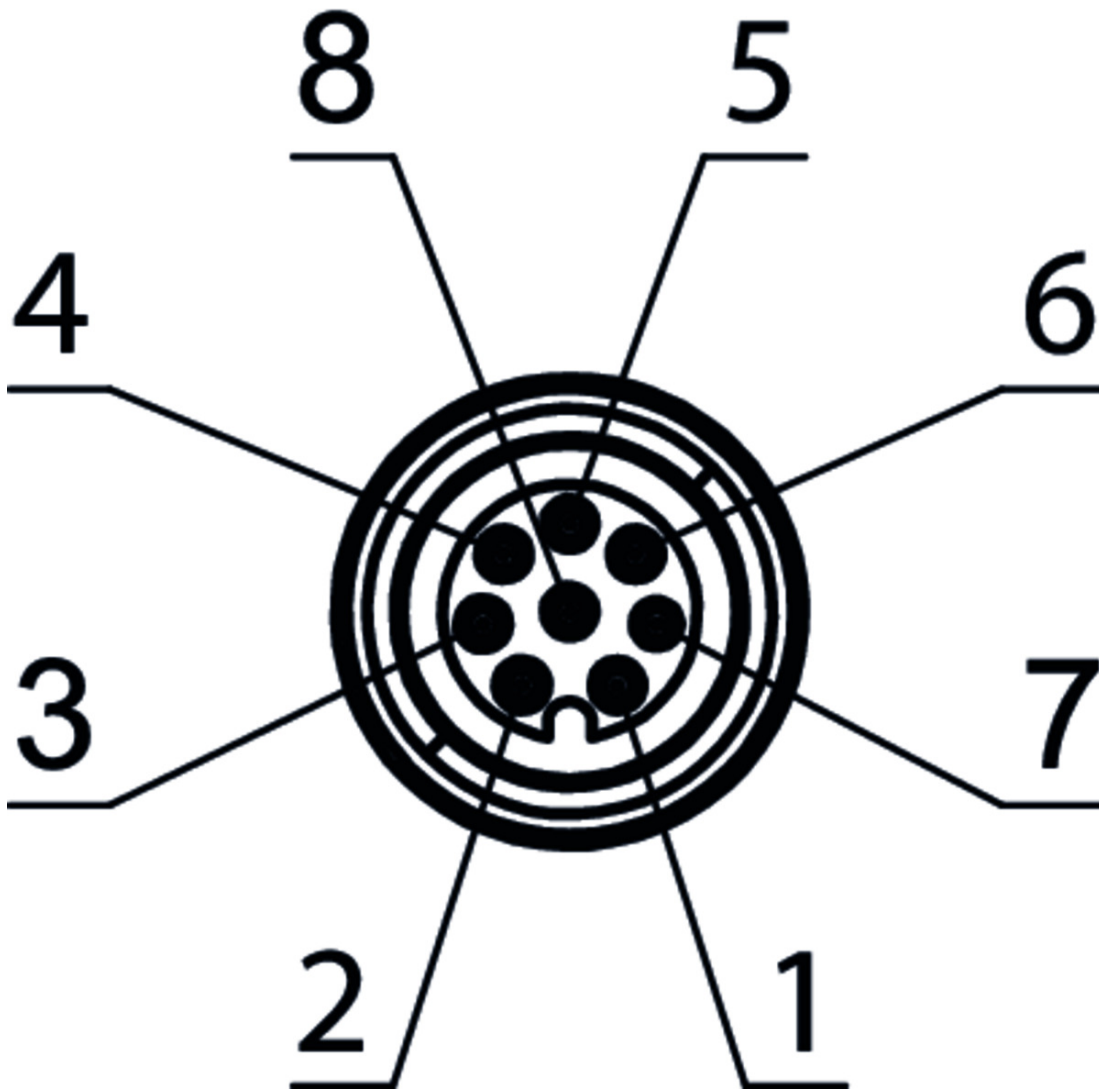

Catalogs

- ✓ Light grids and light curtains LCA Barreras fotoeléctricas y cortinas fotoeléctricas LCA Barrières photoélectriques et rideaux lumineux LCA Lichtgitter und Lichtvorhänge LCA

	Doc. no.	Version	Language	Download
Lichtgitter und Lichtvorhänge LCA	157084	03-03/18		2.5 MB
Barrières photoélectriques et rideaux lumineux LCA	157086	03-03/18		2.5 MB
Barreras fotoeléctricas y cortinas fotoeléctricas LCA	157087	03-03/18		2.5 MB
Light grids and light curtains LCA	157085	03-03/18		2.5 MB













- ✓ Transpondercodierte Sicherheitsschalter - Verriegelungseinrichtungen und Zuhaltungen
Transponder-coded safety switches - Interlocking devices and guard locking devices
Interruptores de seguridad con codificación por transponder - Dispositivos de enclavamiento y bloqueos
Interrupteurs de sécurité à codage par transpondeur - Dispositifs de verrouillage et interverrouillages

	Doc. no.	Version	Language	Download
Transpondercodierte Sicherheitsschalter - Verriegelungseinrichtungen und Zuhaltungen	127594	02-01/18		 5.2 MB
Interrupteurs de sécurité à codage par transpondeur - Dispositifs de verrouillage et interverrouillages	137558	02-01/18		 5.2 MB
Interruptores de seguridad con codificación por transponder - Dispositivos de enclavamiento y bloqueos	137560	02-01/18		 5.2 MB
Transponder-coded safety switches - Interlocking devices and guard locking devices	127595	02-01/18		 5.1 MB

Bezpečnostní spínače s plastovým pouzdrém Sicherheitsschalter mit Kunststoffgehäuse Safety Switches with Plastic Housing Interruptores de seguridad con carcasa plástica Interrupteurs de sécurité avec boîtier plastique 塑料壳体的安全开关

	Doc. no.	Version	Language	Download
Sicherheitsschalter mit Kunststoffgehäuse	096955	11-03/18		 6.6 MB
Interrupteurs de sécurité avec boîtier plastique	100677	11-03/18		 6.6 MB
Interruptores de seguridad con carcasa plástica	104855	11-03/18		 6.6 MB
Bezpečnostní spínače s plastovým pouzdrém	121649	11-03/18		 6.6 MB
Safety Switches with Plastic Housing	096956	11-03/18		 6.6 MB
塑料壳体的安全开关	116243	11-03/18		 6.2 MB

Sicherheitsschalter mit Metallgehäuse Safety Switches with Metal Housing Bezpečnostní spínače s kovovým pouzdrém Interrupteurs de sécurité avec boîtier métallique 金属壳体的安全开关 Interruptores de seguridad con carcasa metálica

	Doc. no.	Version	Language	Download
Sicherheitsschalter mit Metallgehäuse	100319	11-03/18		 7.9 MB
Interrupteurs de sécurité avec boîtier métallique	100676	11-03/18		 7.9 MB
Interruptores de seguridad con carcasa metálica	104856	11-03/18		 14.0 MB
Safety Switches with Metal Housing	100369	11-03/18		 7.9 MB
Bezpečnostní spínače s kovovým pouzdrém	121650	11-03/18		 7.9 MB
金属壳体的安全开关	102453	11-03/18		 8.2 MB