

**ITEM 115257 C-M12F08-08X025PU30,0-MA-115257**

|             |                |             |           |
|-------------|----------------|-------------|-----------|
| Description | Technical data | Accessories | Downloads |
|-------------|----------------|-------------|-----------|

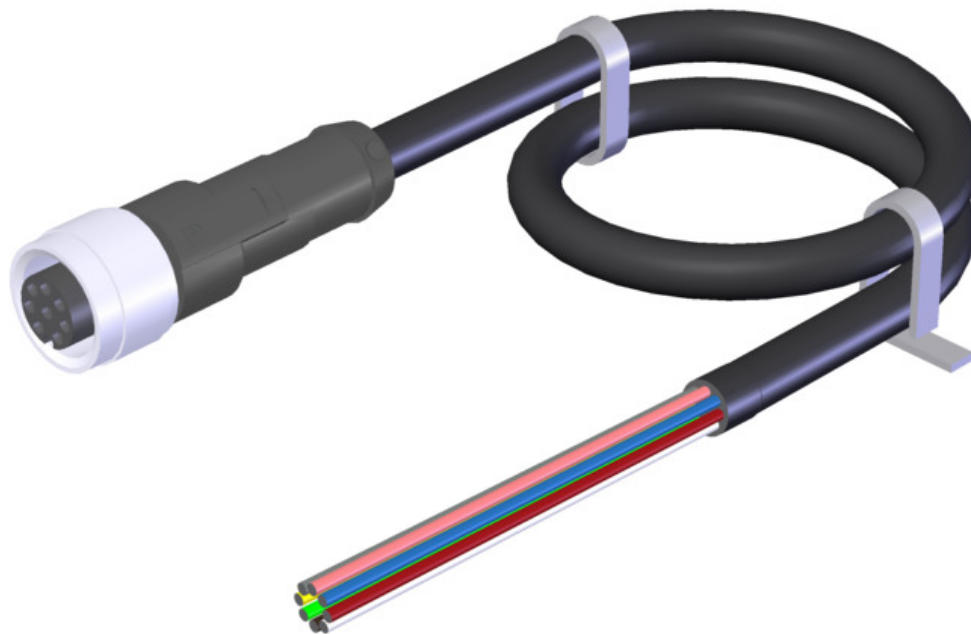

**Features**

- › M12 female plug, 8-pin
- › Straight plug connector
- › PUR cable
- › Cable length 30 m
- › With flying lead

**Terminal assignment**

| View of connection side | Pin | Conductor coloring |
|-------------------------|-----|--------------------|
|                         | 1   | WH                 |
|                         | 2   | BN                 |
|                         | 3   | GN                 |
|                         | 4   | YE                 |
|                         | 5   | GY                 |
|                         | 6   | PK                 |
|                         | 7   | BU                 |
|                         | 8   | RD                 |

## Mechanical values and environment

|                         |  |
|-------------------------|--|
| Plug lock material      | CuZn/ Ni   |
| Sheath material         | PUR  |
| Fire behavior           | Flame retardant  |
| Halogen-free            | Yes <b>[1]</b>   |
| Drag chain suitability  | Yes  |
| Ambient temperature     | static -25 ... +80 °C<br>Dynamic -25 ... +80 °C          |
| Number of conductors    | 8  |
| Type of cable           | straight   |
| Cable length            | 30 m   |
| Cable diameter          | Approx. 5,9 mm   |
| Conductor cross-section | 0.25 mm <sup>2</sup>                                     |
| Sheath color            | Black  |
| Bending radius          | static 8 x cable diameter<br>Dynamic 10 x cable diameter |
|                         | <b>Connection 1</b>                                      |
| Degree of protection    | IP 67 <b>[2]</b>   |
| Insertion cycles        | 100  |
| Connection              | Plug connectors M12x1                                    |
| Connection type         | Socket   |
| Cable outlet            | straight   |
| Number of pins          | 8  |
| Plug lock               | Screw connection   |
| Plug housing material   | TPU  |
|                         | <b>Connection 2</b>                                      |
| Conductor end           | Sheath stripped  |
| Connection              | Flying lead  |

## Electrical connection ratings

|   |                     |
|---|---------------------|
| Nominal current                                 | At 25° C 2 A        |
|   | <b>Connection 1</b> |
| Degree of contamination according to EN 60664-1 | 3                   |

[1] According to DIN VDE 0472 part 815

[2] In the inserted state

### Dimension drawing

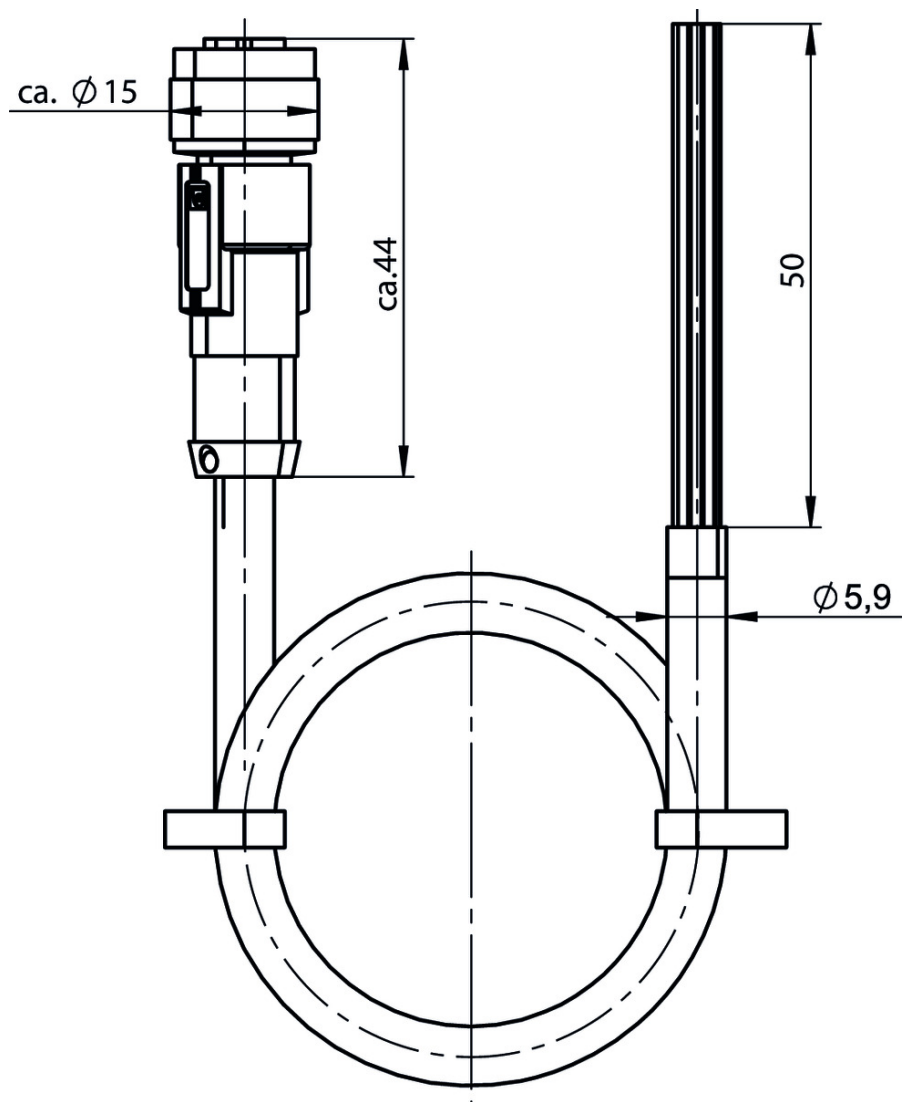

## Terminal assignment

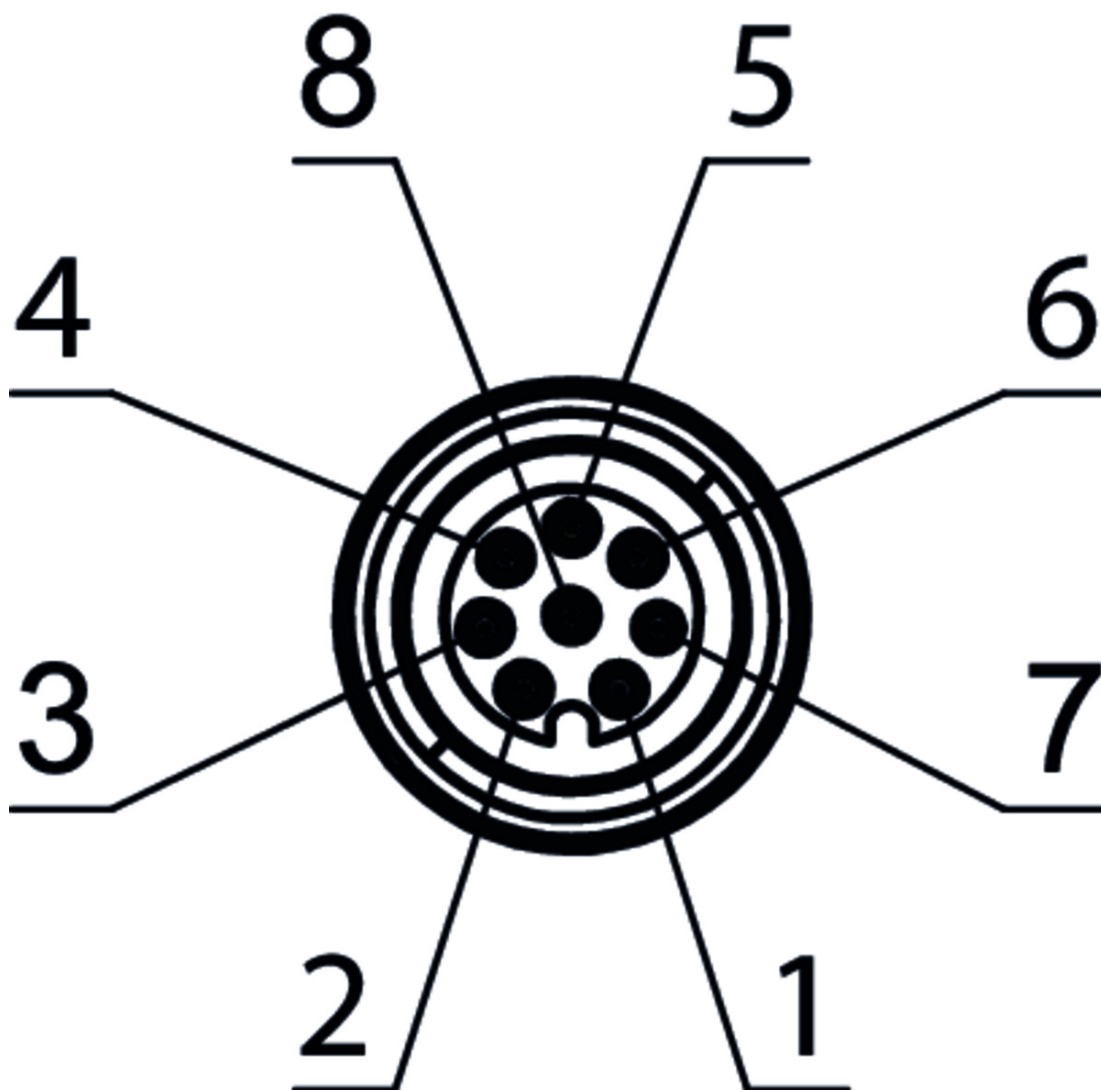

## Catalogs

- ✓ Light grids and light curtains LCA Barreras fotoeléctricas y cortinas fotoeléctricas LCA Barrières photoélectriques et rideaux lumineux LCA Lichtgitter und Lichtvorhänge LCA

|   | Doc. no. | Version  | Language | Download |
|---|----------|----------|----------|----------|
| Lichtgitter und Lichtvorhänge LCA                     | 157084   | 03-03/18 |          | 2.5 MB   |
| Barrières photoélectriques et rideaux lumineux LCA    | 157086   | 03-03/18 |          | 2.5 MB   |
| Barreras fotoeléctricas y cortinas fotoeléctricas LCA | 157087   | 03-03/18 |          | 2.5 MB   |
| Light grids and light curtains LCA                    | 157085   | 03-03/18 |          | 2.5 MB   |













- ✓ Transpondercodierte Sicherheitsschalter - Verriegelungseinrichtungen und Zuhaltungen  
Transponder-coded safety switches - Interlocking devices and guard locking devices  
Interruptores de seguridad con codificación por transponder - Dispositivos de enclavamiento y bloqueos  
Interrupteurs de sécurité à codage par transpondeur - Dispositifs de verrouillage et interverrouillages

|   | Doc. no. | Version  | Language  | Download   |
|---|----------|----------|---|--|
| Transpondercodierte Sicherheitsschalter - Verriegelungseinrichtungen und Zuhaltungen                    | 127594   | 02-01/18 |  |  5.2 MB |
| Interrupteurs de sécurité à codage par transpondeur - Dispositifs de verrouillage et interverrouillages | 137558   | 02-01/18 |  |  5.2 MB |
| Interruptores de seguridad con codificación por transponder - Dispositivos de enclavamiento y bloqueos  | 137560   | 02-01/18 |  |  5.2 MB |
| Transponder-coded safety switches - Interlocking devices and guard locking devices                      | 127595   | 02-01/18 |  |  5.1 MB |

 **Bezpečnostní spínače s plastovým pouzdrém Sicherheitsschalter mit Kunststoffgehäuse Safety Switches with Plastic Housing Interruptores de seguridad con carcasa plástica Interrupteurs de sécurité avec boîtier plastique 塑料壳体的安全开关**

|  | Doc. no. | Version  | Language  | Download   |
|--|----------|----------|---|--|
| Sicherheitsschalter mit Kunststoffgehäuse        | 096955   | 11-03/18 |    |  6.6 MB   |
| Interrupteurs de sécurité avec boîtier plastique | 100677   | 11-03/18 |    |  6.6 MB   |
| Interruptores de seguridad con carcasa plástica  | 104855   | 11-03/18 |    |  6.6 MB   |
| Bezpečnostní spínače s plastovým pouzdrém        | 121649   | 11-03/18 |    |  6.6 MB   |
| Safety Switches with Plastic Housing             | 096956   | 11-03/18 |    |  6.6 MB   |
| 塑料壳体的安全开关  | 116243   | 11-03/18 |  |  6.2 MB |

 **Sicherheitsschalter mit Metallgehäuse Safety Switches with Metal Housing Bezpečnostní spínače s kovovým pouzdrém Interrupteurs de sécurité avec boîtier métallique 金属壳体的安全开关 Interruptores de seguridad con carcasa metálica**

|   | Doc. no. | Version  | Language  | Download  |
|---|----------|----------|---|---|
| Sicherheitsschalter mit Metallgehäuse             | 100319   | 11-03/18 |  |  7.9 MB  |
| Interrupteurs de sécurité avec boîtier métallique | 100676   | 11-03/18 |  |  7.9 MB  |
| Interruptores de seguridad con carcasa metálica   | 104856   | 11-03/18 |  |  14.0 MB |
| Safety Switches with Metal Housing                | 100369   | 11-03/18 |  |  7.9 MB  |
| Bezpečnostní spínače s kovovým pouzdrém           | 121650   | 11-03/18 |  |  7.9 MB  |
| 金属壳体的安全开关   | 102453   | 11-03/18 |  |  8.2 MB  |