

ITEM 113869 A-C40-113869

Description	Technical data	Accessories	Downloads
-------------	----------------	-------------	-----------



Features

- › Locking force 600 N
- › Two screws M5x16 (one as safety screw) included

Actuator

The anchor plate for the CEM actuator has spring mountings and can be tilted to an angle of +/-4°.

Therefore, when a misadjusted safety door is closed, the CEM actuator automatically adjusts itself to the surface of the solenoid. Subsequent adjustment of the safety door is no longer necessary. Even with a center offset of 5 mm (anchor plate in relation to solenoid) the full locking force is achieved.

Mechanical values and environment

Material	Actuator installed	Plastic (PBT)
	Anchor plate	Steel, nickel-plated
Housing material		Die-cast aluminum

Weight	0,24 kg
Ambient temperature	-25 ... 55 °C
Degree of protection	IP67
Installation position	Active face opposite read head
Angle offset	-4 ... +4 °
Method of operation	Inductive

Dimension drawing

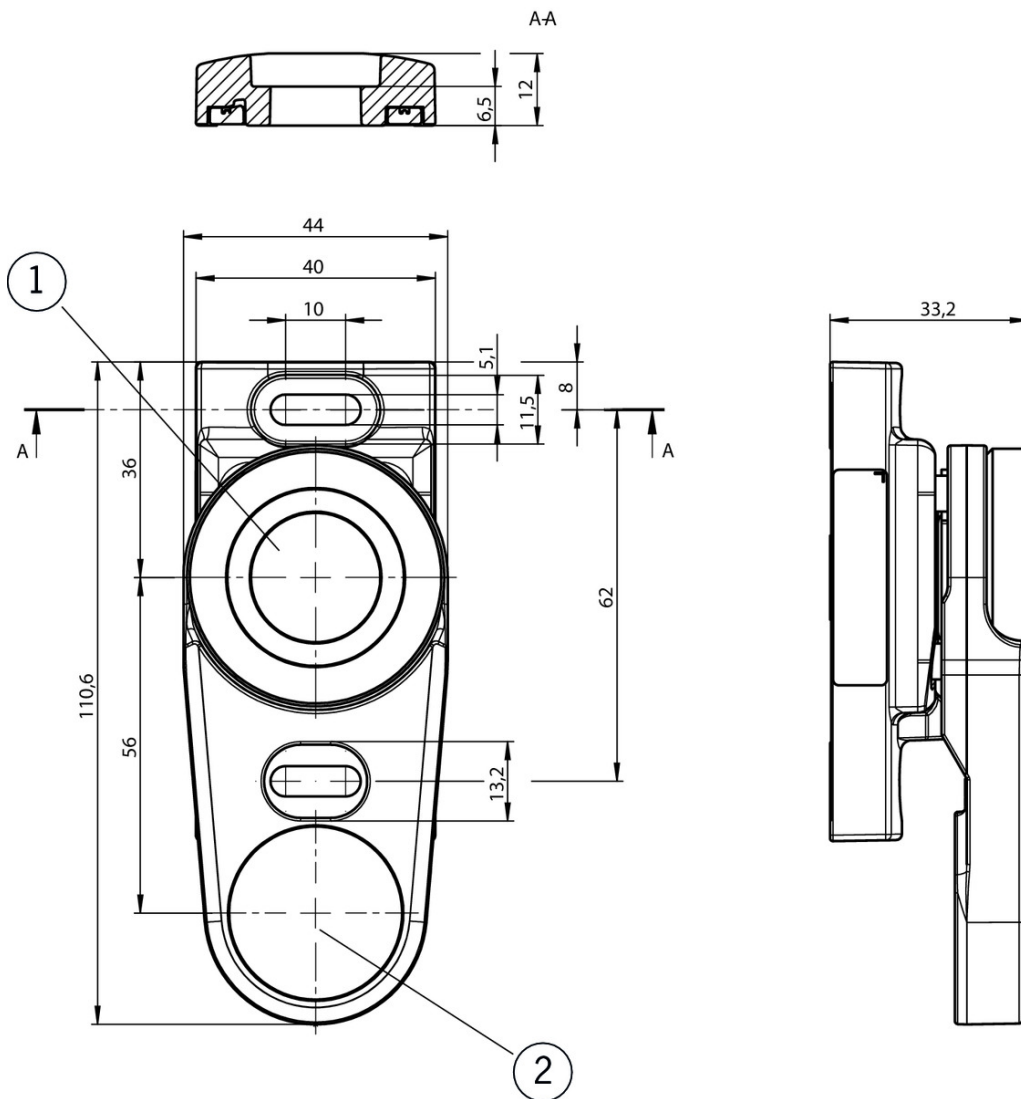

Legende

- 1 Anchor plate
- 2 Transponder, active actuator face

Mounting accessories

▼ Safety screws for actuators, M5 x 16



073456 M5X16/V100

▼ Features

- › Safety screws M5 x 16
- › Packaging unit 100 pieces

Catalogs









▼ Transpondercodierter Sicherheitsschalter CEM-AR-C40

	Doc. no.	Version	Language	Download
Transpondercodierter Sicherheitsschalter CEM-AR-C40	126106	02-01/16	 	 0.2 MB
Transponder-coded safety switch CEM-AR-C40				

▼ Interruptor de seguridad con codificación por transponder CEM-AR-C40

	Doc. no.	Version	Language	Download
Interruptor de seguridad con codificación por transponder CEM-AR-C40	126943	02-01/16	 	 0.2 MB
Interrupteur de sécurité à codage par transpondeur CEM-AR-C40				

▼ Transpondercodierte Sicherheitsschalter - Verriegelungseinrichtungen und Zuhaltungen Transponder-coded safety switches - Interlocking devices and guard locking devices Interruptores de seguridad con codificación por transponder - Dispositivos de enclavamiento y bloqueos Interrupteurs de sécurité à codage par transpondeur - Dispositifs de verrouillage et interverrouillages

	Doc. no.	Version	Language	Download
Transpondercodierte Sicherheitsschalter - Verriegelungseinrichtungen und Zuhaltungen	127594	02-01/18		 5.2 MB
Interrupteurs de sécurité à codage par transpondeur - Dispositifs de verrouillage et interverrouillages	137558	02-01/18		 5.2 MB
Interruptores de seguridad con codificación por transponder - Dispositivos de enclavamiento y bloqueos	137560	02-01/18		 5.2 MB
Transponder-coded safety switches - Interlocking devices and guard locking devices	127595	02-01/18		 5.1 MB