

ITEM 113640 C-M12F05-05X034PU10,0-MA-113640

Description	Technical data	Accessories	Downloads
-------------	----------------	-------------	-----------

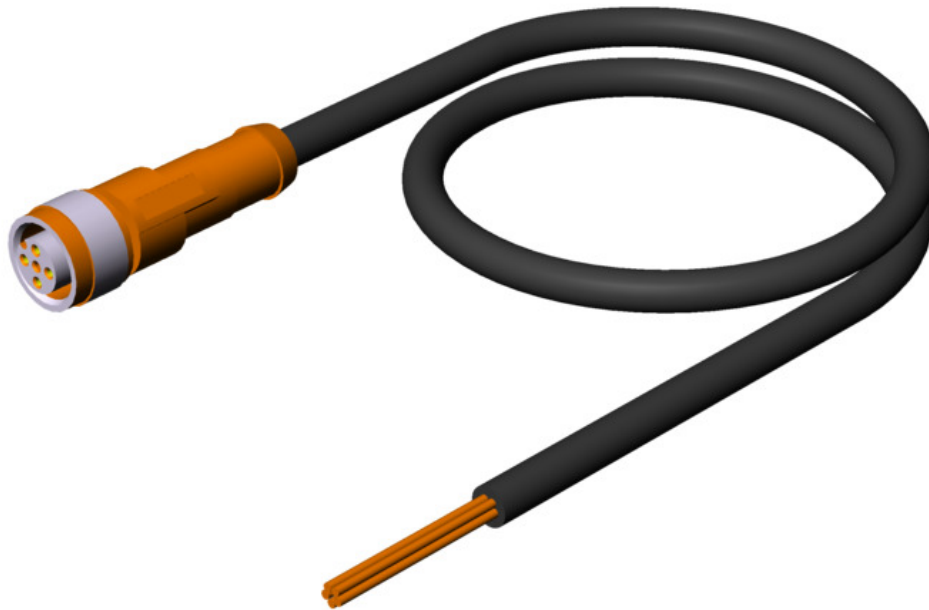

Features

- › M12 female plug, 5-pin
- › Straight plug connector
- › PUR cable
- › Cable length 10 m
- › With flying lead

Mechanical values and environment

Sheath material	PUR
Fire behavior	Flame retardant
Halogen-free	Yes ^[1]
Drag chain suitability	Yes
Ambient temperature	
static	-25 ... +80 °C
Dynamic	-25 ... +80 °C
Number of conductors	5
Type of cable	straight

Cable length	10 m
Cable diameter	
Approx.	5 mm
Conductor cross-section	0.34 mm ²
Sheath color	Black
Bending radius	
static	5 x cable diameter
Dynamic	10 x cable diameter
Connection 1	
Degree of protection	IP 67 [2]
Plug lock material	CuZn/ Ni
Insertion cycles	100
Connection	Plug connectors M12x1
Connection type	Socket
Cable outlet	straight
Number of pins	5
Plug lock	Screw connection
Plug housing material	TPU
Connection 2	
Conductor end	Sheath stripped
Connection	Flying lead

Electrical connection ratings

Nominal current	
At 25° C	4 A
Rated voltage	60 V
Connection 1	
Degree of contamination according to EN 60664-1	3

[1] According to DIN VDE 0472 part 815

[2] In the inserted state

Dimension drawing

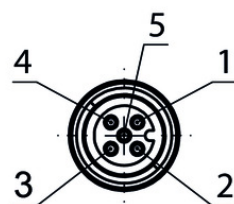
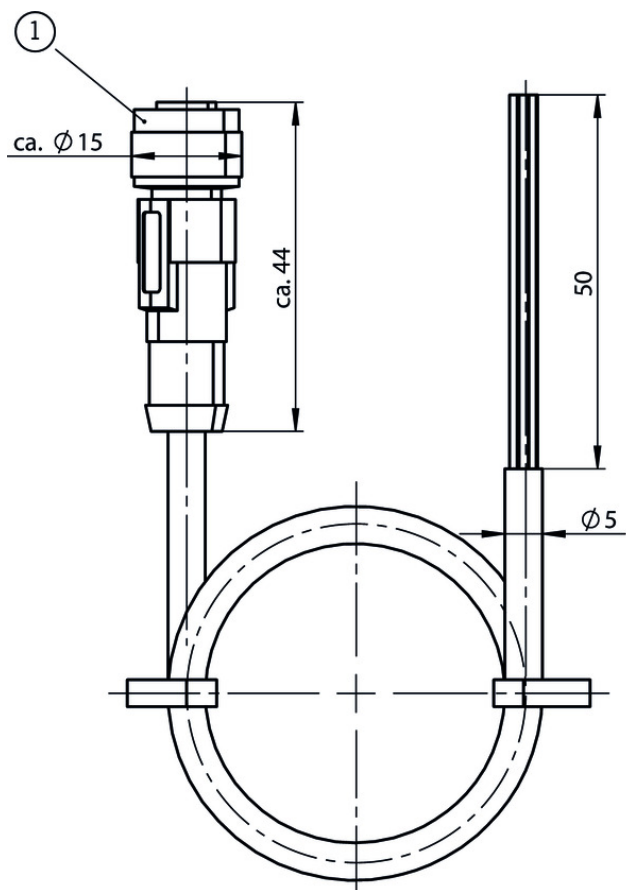

PIN 1 = BN
 PIN 2 = WH
 PIN 3 = BU
 PIN 4 = BK
 PIN 5 = GY

Legende

1 Female plug M12x1, 5-pin

Catalogs

Light grids and light curtains LCA Barreras fotoeléctricas y cortinas fotoeléctricas LCA Barrières photoélectriques et rideaux lumineux LCA Lichtgitter und Lichtvorhänge LCA









	Doc. no.	Version	Language	Download
Lichtgitter und Lichtvorhänge LCA	157084	03-03/18		2.5 MB
Barrières photoélectriques et rideaux lumineux LCA	157086	03-03/18		2.5 MB
Barreras fotoeléctricas y cortinas fotoeléctricas LCA	157087	03-03/18		2.5 MB
Light grids and light curtains LCA	157085	03-03/18		2.5 MB

Transpondercodierte Sicherheitsschalter - Verriegelungseinrichtungen und Zuhaltungen
 Transponder-coded safety switches - Interlocking devices and guard locking devices
 Interruptores de seguridad con codificación por transponder - Dispositivos de enclavamiento y bloqueos
 Interrupteurs de sécurité à codage par transpondeur - Dispositifs de verrouillage et

interverrouillages

	Doc. no.	Version	Language	Download
Transpondercodierte Sicherheitsschalter - Verriegelungseinrichtungen und Zuhaltungen	127594	02-01/18		 5.2 MB
Interrupteurs de sécurité à codage par transpondeur - Dispositifs de verrouillage et interverrouillages	137558	02-01/18		 5.2 MB
Interruptores de seguridad con codificación por transponder - Dispositivos de enclavamiento y bloqueos	137560	02-01/18		 5.2 MB
Transponder-coded safety switches - Interlocking devices and guard locking devices	127595	02-01/18		 5.1 MB

-  Transpondercodierte Sicherheitssysteme mit externer Auswertung Transponder-coded safety systems with external evaluation Sistemas de seguridad con codificación por transponder y evaluación externa Systèmes de sécurité à codage par transpondeur avec analyse externe

	Doc. no.	Version	Language	Download
Transpondercodierte Sicherheitssysteme mit externer Auswertung	127596	02-01/18		 3.1 MB
Systèmes de sécurité à codage par transpondeur avec analyse externe	137968	02-01/18		 3.0 MB
Sistemas de seguridad con codificación por transponder y evaluación externa	139969	02-01/18		 3.0 MB
Transponder-coded safety systems with external evaluation	127597	02-01/18		 3.0 MB