

## ITEM 109016 NZ2RG-2131L024GEC2300

Description	Technical data	Accessories	Downloads
-------------	----------------	-------------	-----------



### Features

- › Type C according to EN 50041(plastic roller  $\varnothing$  12 mm)
- › Plug connector SM8
- › LED indicator

### Approach direction

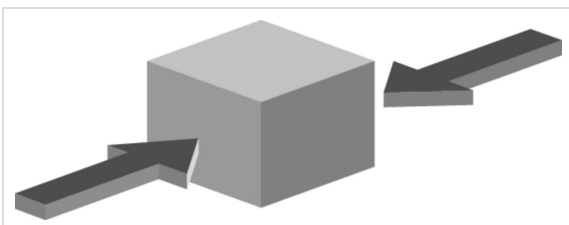

- › Figure  
Horizontal  
Can be adjusted in 90° steps

### Switching element

**2131H** Slow-action switching contact 3 NC $\ominus$  + 1 NO

## Approvals



## Mechanical values and environment

Housing material	Anodized die-cast alloy
Weight	Net 0,3 kg
Ambient temperature	-25 ... 80 °C
Degree of protection	IP67
Mechanical life	30 x 10 <sup>6</sup>
Contact material	Silver alloy, gold flashed
Switching principle	Slow-action switching contact
Installation position	Any
Number of door position positively driven contacts	3
Number of NO contacts	1
Connection	1 x Plug connector M12 [1]
Approach speed	max. 0,1 ... 20 m/min
Actuating element	Plain bearing plastic Roller plunger [2]
Actuating force	15 ... 30 N

## Electrical connection ratings

Rated thermal current $I_{th}$	1 A
Utilization category according to EN 60947-5-1	AC-15 1A 30V DC-13 1A 24V
Short circuit protection according to IEC 60269-1	(Fuse) 1A gG
Rated insulation voltage $U_i$	30 V
Rated impulse withstand voltage $U_{imp}$	1,5 kV
Switching current	Min. at DC 24V 1 mA
Display module	24 V 10% ... 10%

## Miscellaneous

Additional feature	Housing without earth conductor! All the electrical connections must either be isolated from the mains supply by a safety transformer according IEC 61558-2-6 with limited output voltage in the event of a fault, or by other equivalent isolation measures.
C number C2300	[3]

### Reliability values acc. to EN ISO 13849-1

	Monitoring of the safety guard position
B10 <sub>D</sub>	20 x 10 <sup>6</sup>

---

[1] 8-pin without PE

[2] Plastic roller d roller = 12 mm

[3] With 4-fold element + yellow LED, M12x1, 8-pin plug, circuit board with LED bonded in the cover

## Dimension drawing

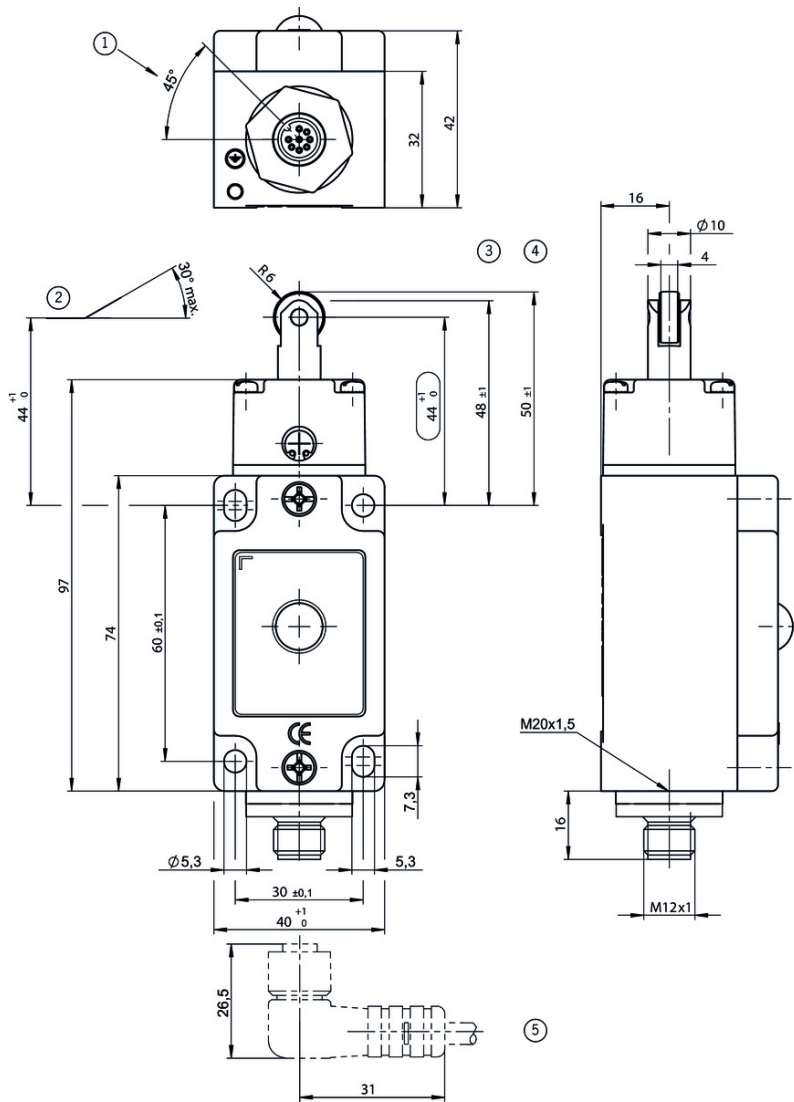

## Legende

- 1 Guide lug aligned
- 2 Dog
- 3 Operating point
- 4 Free position
- 5 Angle plug connector, default setting for cable outlet right

## Wiring diagram

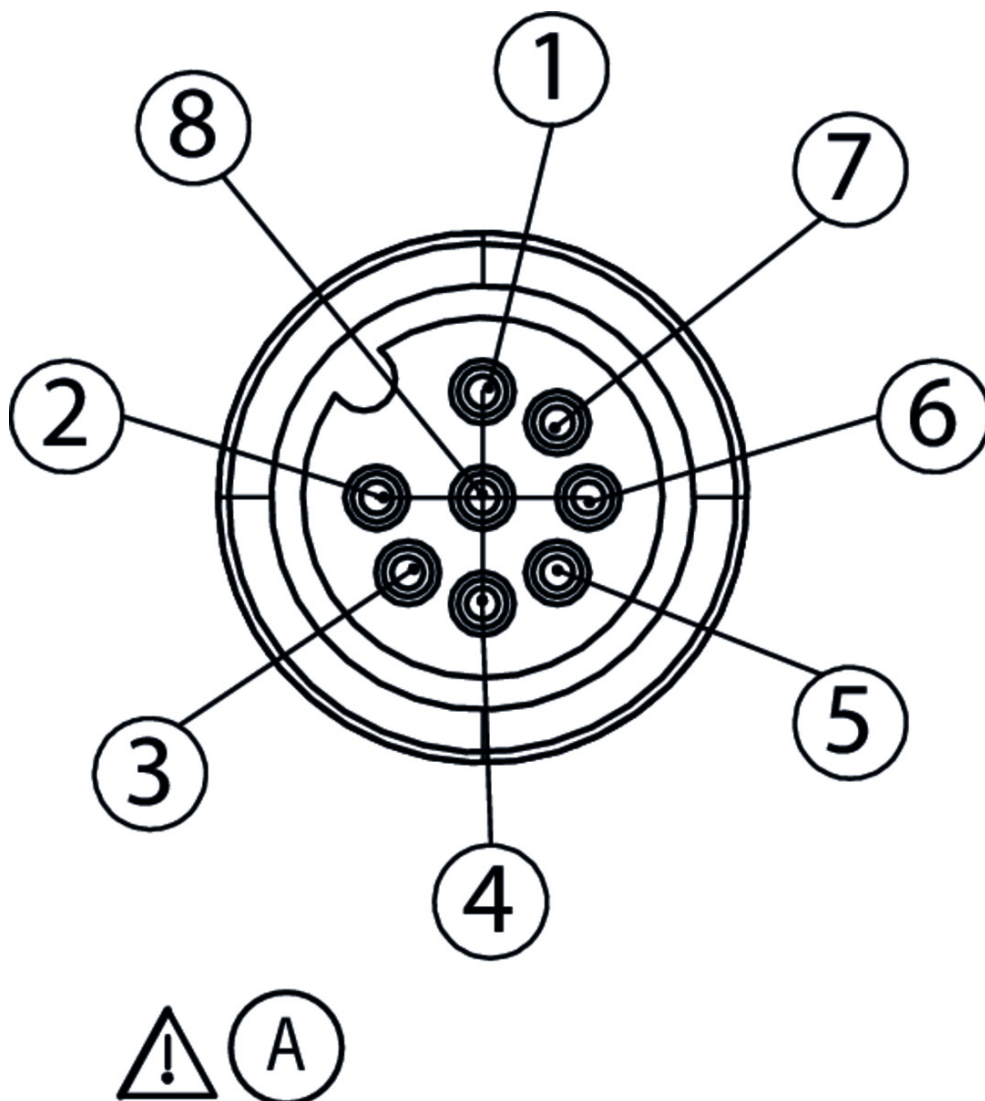

## Legende

A Without earth conductor

1 WH

2 BN

3 GN

4 YE

5 GY

6 PK

7 BU

8 RD

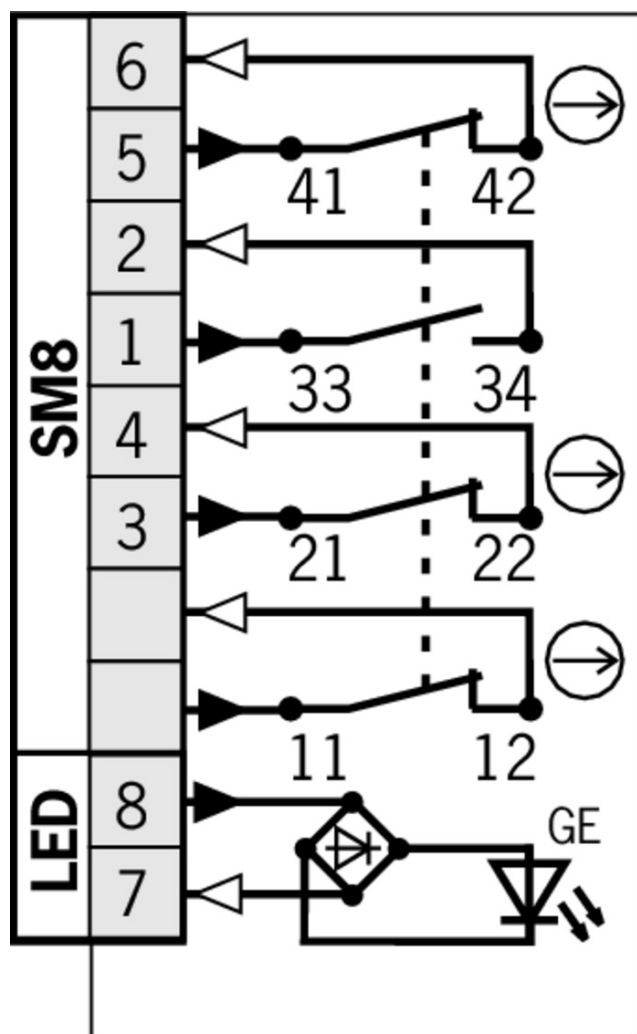

## Switching functions

**NZ.RS**  
**NZ...RG**



**2131H**

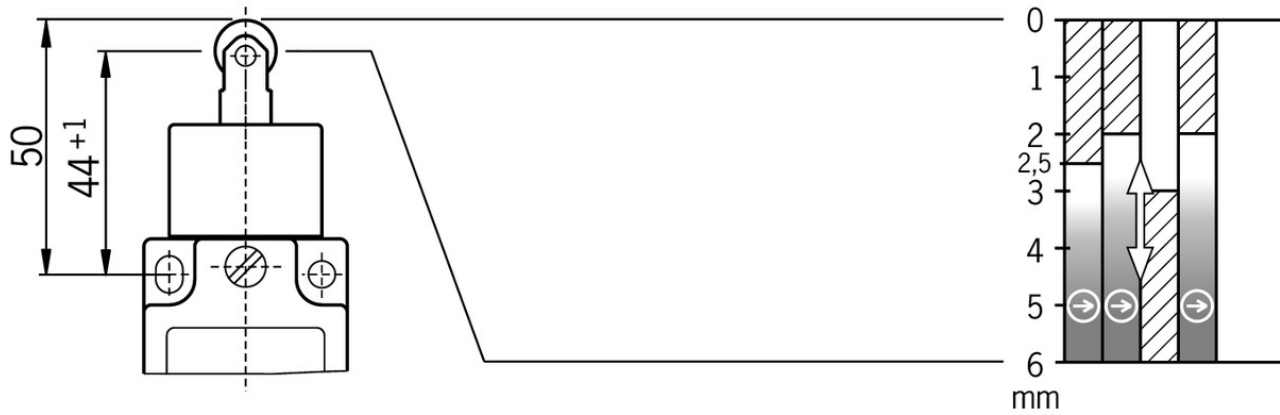

11-12  
21-22  
33-34  
41-42



## Legende

-  Contacts closed
-  Contacts open
-  Contacts positively driven

## Connection material

-  Connection cable with plug connector M12, 8-pin, 5m



**100177** C-M12F08-08X025PV05,0-MA-100177

### Features

- › M12 female plug, 8-pin
- › Straight plug connector
- › PVC cable
- › Cable length 5 m
- › With flying lead



**115112** C-M12F08-08X025PU05,0-MA-115112

### Features

- › M12 female plug, 8-pin
- › Straight plug connector
- › PUR cable
- › Cable length 5 m
- › With flying lead

-  Connection cable with plug connector M12, 8-pin, 10m



**100178** C-M12F08-08X025PV10,0-MA-100178

✓ Features

- › M12 female plug, 8-pin
  - › Straight plug connector
  - › PVC cable
  - › Cable length 10 m
  - › With flying lead
- 



**115113** C-M12F08-08X025PU10,0-MA-115113

✓ Features

- › M12 female plug, 8-pin
  - › Straight plug connector
  - › PUR cable
  - › Cable length 10 m
  - › With flying lead
- 

✓ Connection cable with plug connector M12, 8-pin, 20m



**100179** C-M12F08-08X025PV20,0-MA-100179

✓ Features

- › M12 female plug, 8-pin
  - › Straight plug connector
  - › PVC cable
  - › Cable length 20 m
  - › With flying lead
- 



**115114** C-M12F08-08X025PU20,0-MA-115114

✓ Features

- › M12 female plug, 8-pin
  - › Straight plug connector
  - › PUR cable
  - › Cable length 20 m
  - › With flying lead
- 

✓ Connection cable with plug connector M12, 8-pin, 30m



**115116** C-M12F08-08X025PV30,0-MA-115116

✓ Features

- › M12 female plug, 8-pin
  - › Straight plug connector
  - › PVC cable
  - › Cable length 30 m
  - › With flying lead
- 



**115257** C-M12F08-08X025PU30,0-MA-115257

✓ Features

- › M12 female plug, 8-pin
  - › Straight plug connector
  - › PUR cable
  - › Cable length 30 m
  - › With flying lead
-













## Instructions

### ▼ Betriebsanleitung Sicherheitsschalter NZ.D.../NZ.W.../NZ.R...

	Doc. no.	Version	Language	Download
Betriebsanleitung Sicherheitsschalter NZ.D.../NZ.W.../NZ.R...	074549	10-01/17	    	 1.8 MB
Manual de instrucciones Interruptores de seguridad NZ.D.../NZ.W.../NZ.R...				
Mode d'emploi Interrupteur de sécurité NZ.D.../NZ.W.../NZ.R...				
Istruzioni di impiego Finecorsa di sicurezza NZ.D.../NZ.W.../NZ.R...				
Operating Instructions Safety Switch NZ.D.../NZ.W.../NZ.R...				
Instrukcja obsługi Wyłącznik bezpieczeństwa NZ.D.../NZ.W.../NZ.R...	074549	10-01/17		 0.4 MB
Инструкция по эксплуатации Предохранительный выключатель NZ.D.../NZ.W.../NZ.R...	074549	10-01/17		 0.6 MB
Návod na prevádzku Bezpečnostný spínač NZ.D.../NZ.W.../NZ.R...	074549	10-01/17		 0.4 MB







## Catalogs











### ▼ Sicherheitsschalter mit Metallgehäuse Safety Switches with Metal Housing Bezpečnostní spínače s kovovým pouzdem Interrupteurs de sécurité avec boîtier métallique 金属壳体 的安全开关 Interruptores de seguridad con carcasa metálica

	Doc. no.	Version	Language	Download
Sicherheitsschalter mit Metallgehäuse	100319	11-03/18		 7.9 MB
Interrupteurs de sécurité avec boîtier métallique	100676	11-03/18		 7.9 MB
Interruptores de seguridad con carcasa metálica	104856	11-03/18		 14.0 MB
Safety Switches with Metal Housing	100369	11-03/18		 7.9 MB
Bezpečnostní spínače s kovovým pouzdem	121650	11-03/18		 7.9 MB
金属壳体 的安全开关	102453	11-03/18		 8.2 MB

## Declaration of conformity

### ▼ EU prohlášení o shodě

	Doc. no.	Version	Language	Download
EU-Konformitätserklärung Declaración UE de conformidad Déclaration UE de conformité Dichiarazione di conformità EU declaration of conformity	2077153	25-02/17	    	 0.3 MB

EU prohlášení o shodě	2077153	25-02/17		 0.5 MB
EU-overensstemmelseserklæring				
Δήλωση συμμόρφωσης της ΕΕ				
EU-vaatimustenmukaisuusvakuutus				
EU-típusbizonyítvány				
EU-conformiteitsverklaring				
Deklaracja zgodności UE				
Declaração de Conformidade UE				
Declarația de conformitate UE				
EÚ vyhlásenie o zhode			