

## ITEM 129500 RC18EM-C1825

Description	Technical data	Accessories	Downloads
-------------	----------------	-------------	-----------

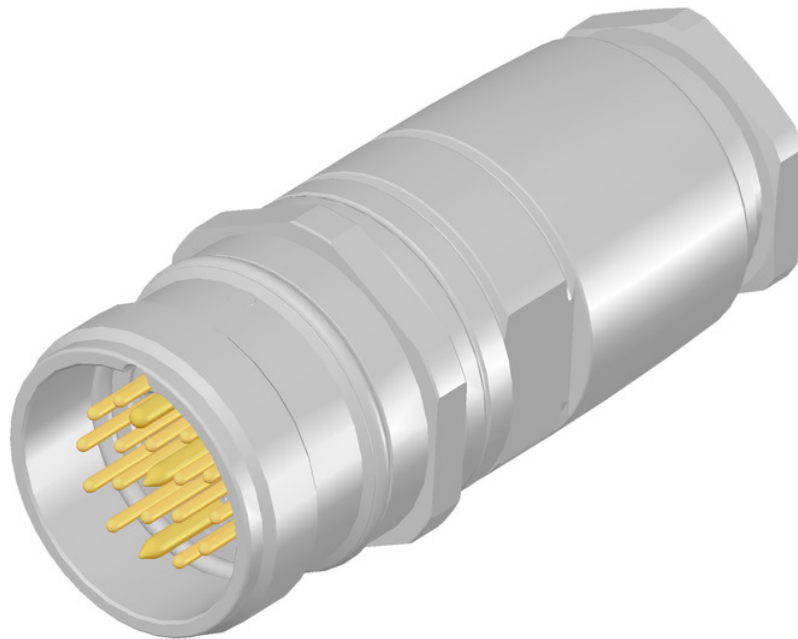

### Features

- › Coupling socket M23, straight
- › Number of pins: 19-pin with screen bonding clamp
- › Suitable for extension of plug RC18EF-1825, RC18WF-1825
- › Replacement crimp contacts available as item number 155811.

### Option C1825

With 16 crimp contacts for conductor cross-section 0.25 - 0.5 mm<sup>2</sup> and 3 contacts for conductor cross-section 0.75 - 1.0 mm<sup>2</sup>.

### Mechanical values and environment

Housing material	brass, nickel-plated
Ambient temperature	-40 ... 80 °C
Degree of protection	IP65 [1]
Contact material	Brass, nickel and gold-plated
Connection	Coupling socket M23

Number of pins	19 16+2+PE
Clamping range for cable	10 ... 14 mm

### Electrical connection ratings

Nominal current	8 A
Rated voltage	150 V
Rated impulse withstand voltage $U_{imp}$	2,5 kV
Overvoltage category according to IEC EN 60664-1	II
Connection cross-section	0,25 ... 0,5 mm <sup>2</sup> [2]
Contact resistance	<3 mΩ

### Miscellaneous

C number	C1825	Connection cross-section 16 x 0.5-1.0 mm <sup>2</sup> / 3 x 0.5-1.0 mm <sup>2</sup>
----------	-------	---

[1] In the inserted and locked state

[2] Crimp connection // pins 6, 12 and 19 - 0.75 mm<sup>2</sup> to 1.0 mm<sup>2</sup>

## Dimension drawing

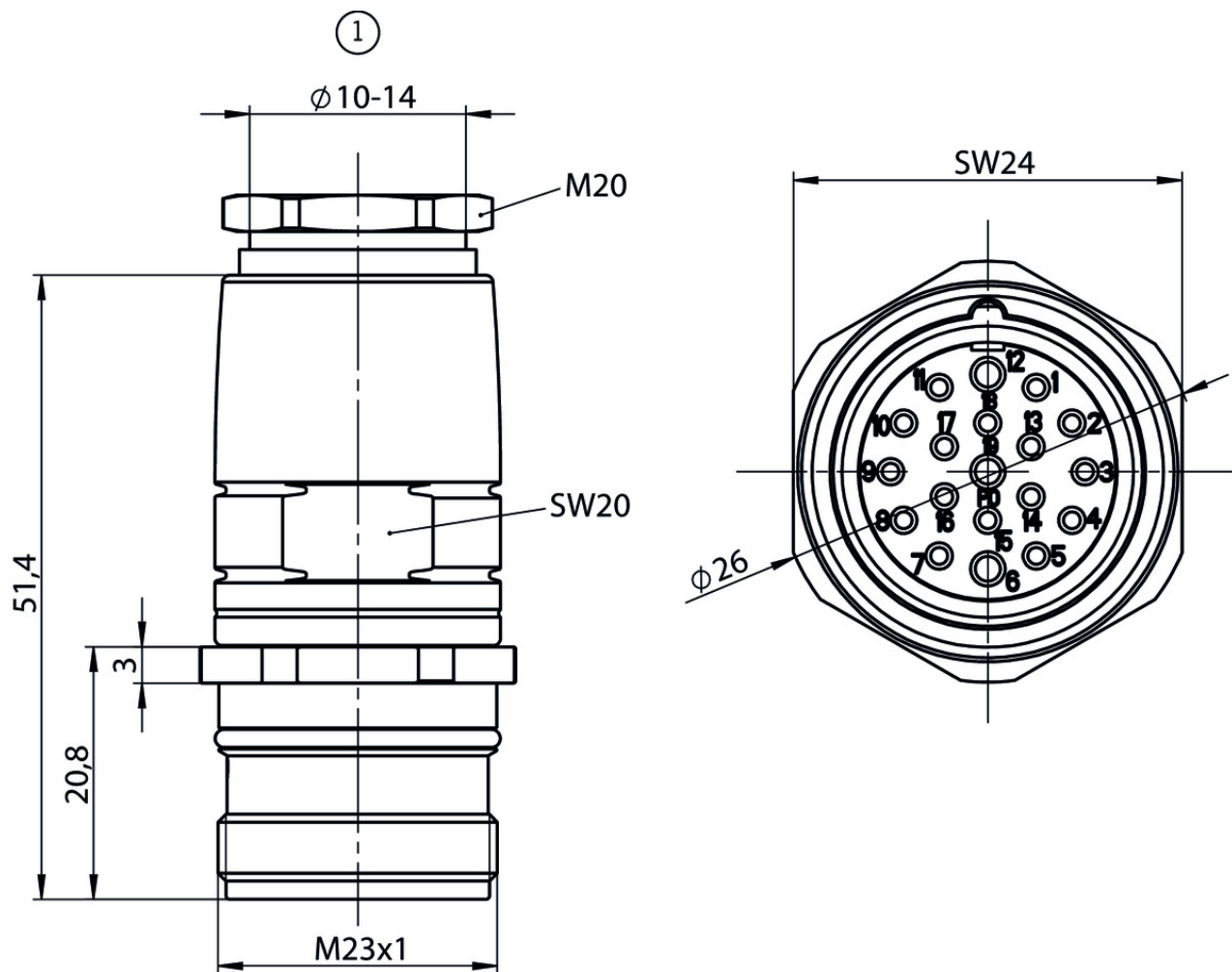

## Connection material

- Replacement crimp contacts for male plug RC18



**155811** CRIMPKONTAKT STIFT RCM-C1825

### Features













- 16 crimp contacts for conductor cross-section 0.25 - 0.5 mm<sup>2</sup>
- 2 crimp contacts for conductor cross-section 0.75 - 1.0 mm<sup>2</sup>
- 1 crimp contact with screen bonding clamp for conductor cross-section 0.75 - 1.0 mm<sup>2</sup>

## Catalogs

- Bezpečnostní spínače s plastovým pouzdrém Sicherheitsschalter mit Kunststoffgehäuse Safety Switches with Plastic Housing Interruptores de seguridad con carcasa plástica Interrupteurs de sécurité avec boîtier plastique 塑料壳体 的安全开关

Sicherheitsschalter mit Kunststoffgehäuse	096955	11-03/18		 6.6 MB
Interrupteurs de sécurité avec boîtier plastique	100677	11-03/18		 6.6 MB
Interruptores de seguridad con carcasa plástica	104855	11-03/18		 6.6 MB
Bezpečnostní spínače s plastovým pouzdem	121649	11-03/18		 6.6 MB
Safety Switches with Plastic Housing	096956	11-03/18		 6.6 MB
塑料壳体 的安全开关	116243	11-03/18		 6.2 MB

 Sicherheitsschalter mit Metallgehäuse Safety Switches with Metal Housing Bezpečnostní spínače s kovovým pouzdem Interrupteurs de sécurité avec boîtier métallique 金属壳体 的安全开关 Interruptores de seguridad con carcasa metálica

	<b>Doc. no.</b>	<b>Version</b>	<b>Language</b>	<b>Download</b>
Sicherheitsschalter mit Metallgehäuse	100319	11-03/18		 7.9 MB
Interrupteurs de sécurité avec boîtier métallique	100676	11-03/18		 7.9 MB
Interruptores de seguridad con carcasa metálica	104856	11-03/18		 14.0 MB
Safety Switches with Metal Housing	100369	11-03/18		 7.9 MB
Bezpečnostní spínače s kovovým pouzdem	121650	11-03/18		 7.9 MB
金属壳体 的安全开关	102453	11-03/18		 8.2 MB