

ITEM 156064 C-M12F05-05X034PV50,0-MA-156064

Description	Technical data	Accessories	Downloads
-------------	----------------	-------------	-----------

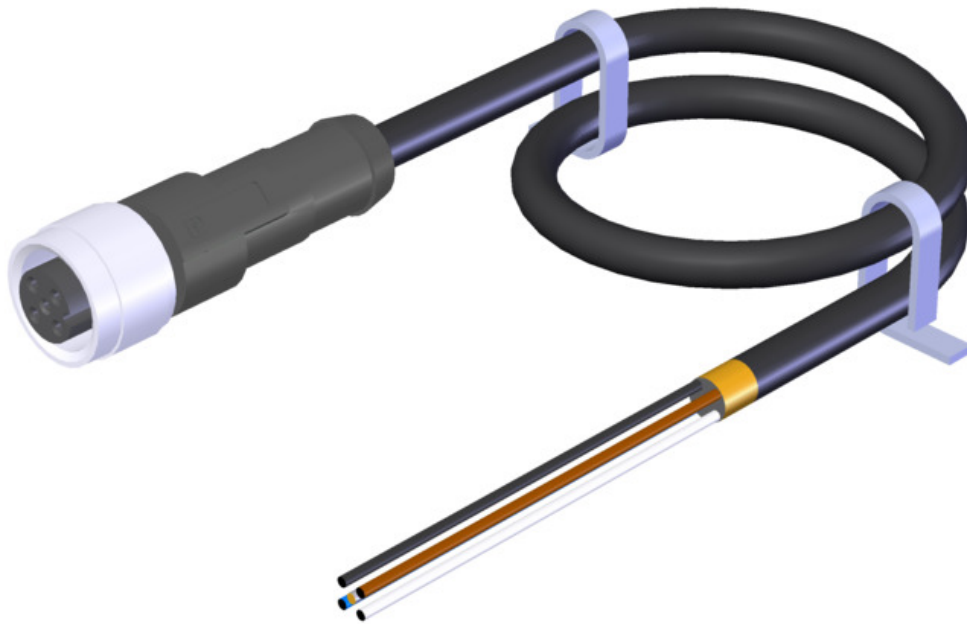

Features

- › M12 female plug, 5-pin
- › Straight plug connector
- › PVC cable
- › Cable length 50 m
- › With flying lead

Mechanical values and environment

Sheath material	PVC
Conductor insulation material	PVC
Conductor material	Cu flexible wire bare
Fire behavior	Flame retardant according to UL-Style 2464
Drag chain suitability	No
UV resistance	Moderately UV-resistant
Ambient temperature	
	static -25 ... +80 °C
	Dynamic -5 ... +80 °C

Number of conductors	5
Type of cable	straight
Cable length	50 m
Cable diameter	Approx. 5,9 mm
Conductor cross-section	0.34 mm ²
Conductor identification	Color code
Sheath color	Black
Bending radius	static 5 x cable diameter Dynamic 15 x cable diameter
Connection 1	
Degree of protection	IP67 [1]
Plug lock material	CuZn, nickel-plated
Insertion cycles	100
Insulating material group	1
Connection	Plug connectors M12x1
Connection type	Socket
Cable outlet	straight
Number of pins	5
Plug lock	Screw connection
Plug housing material	TPU
Connection 2	
Conductor end	Sheath stripped
Connection	Flying lead

Electrical connection ratings

Nominal current	At 25° C 4 A
Rated voltage	60 V
Overtoltage category according to IEC EN 60664-1	III
Rated surge voltage according to IEC 60664-1	1500 V
Specific cable resistance	58 Ω/km
Specific inductance	0,53 mH/km
Specific capacitance	100 nF/km
Connection 1	
Degree of contamination according to EN 60664-1	3

[1] In the inserted state

Dimension drawing

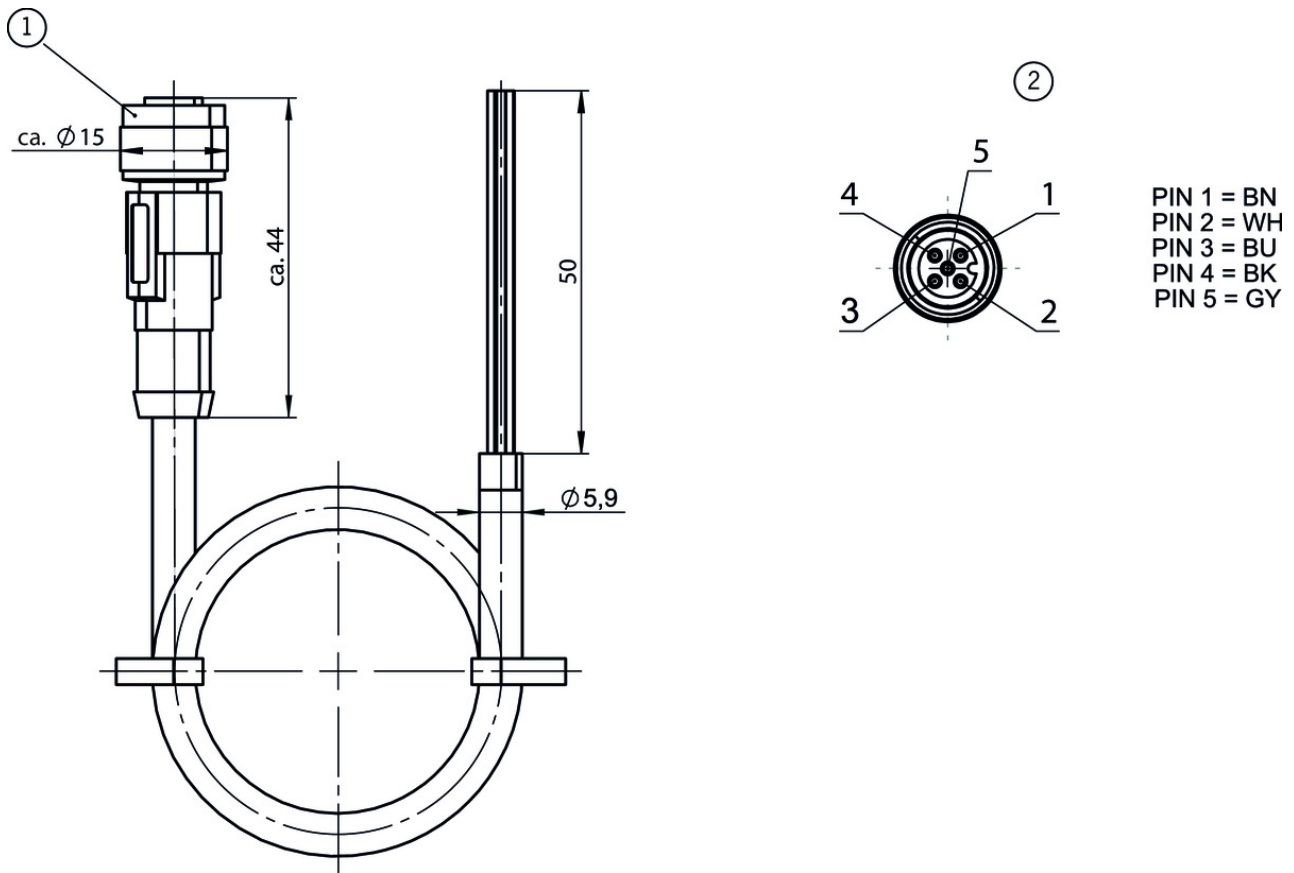

Legende

- 1 Female plug M12x1, 5-pin
- 2 Terminal assignment as seen from the connection side

Catalogs









✓ Light grids and light curtains LCA Barreras fotoeléctricas y cortinas fotoeléctricas LCA Barrières photoélectriques et rideaux lumineux LCA Lichtgitter und Lichtvorhänge LCA

	Doc. no.	Version	Language	Download
Lichtgitter und Lichtvorhänge LCA	157084	03-03/18		2.5 MB
Barrières photoélectriques et rideaux lumineux LCA	157086	03-03/18		2.5 MB
Barreras fotoeléctricas y cortinas fotoeléctricas LCA	157087	03-03/18		2.5 MB
Light grids and light curtains LCA	157085	03-03/18		2.5 MB

- ▼ Transpondercodierte Sicherheitsschalter - Verriegelungseinrichtungen und Zuhaltungen
 Transponder-coded safety switches - Interlocking devices and guard locking devices
 Interruptores de seguridad con codificación por transponder - Dispositivos de enclavamiento y bloqueos
 Interrupteurs de sécurité à codage par transpondeur - Dispositifs de verrouillage et interverrouillages

	Doc. no.	Version	Language	Download
Transpondercodierte Sicherheitsschalter - Verriegelungseinrichtungen und Zuhaltungen	127594	02-01/18		 5.2 MB
Interrupteurs de sécurité à codage par transpondeur - Dispositifs de verrouillage et interverrouillages	137558	02-01/18		 5.2 MB
Interruptores de seguridad con codificación por transponder - Dispositivos de enclavamiento y bloqueos	137560	02-01/18		 5.2 MB
Transponder-coded safety switches - Interlocking devices and guard locking devices	127595	02-01/18		 5.1 MB

- ▼ Transpondercodierte Sicherheitssysteme mit externer Auswertung
 Transponder-coded safety systems with external evaluation
 Sistemas de seguridad con codificación por transponder y evaluación externa
 Systèmes de sécurité à codage par transpondeur avec analyse externe

	Doc. no.	Version	Language	Download
Transpondercodierte Sicherheitssysteme mit externer Auswertung	127596	02-01/18		 3.1 MB
Systèmes de sécurité à codage par transpondeur avec analyse externe	137968	02-01/18		 3.0 MB
Sistemas de seguridad con codificación por transponder y evaluación externa	139969	02-01/18		 3.0 MB
Transponder-coded safety systems with external evaluation	127597	02-01/18		 3.0 MB