

ITEM 128196 EGM12-1200C2463

Description	Technical data	Accessories	Downloads
-------------	----------------	-------------	-----------



Features

- › For sealing with O-rings
- › With snap-action switching element
- › Plunger material stainless steel
- › Any installation position

Switching element

Snap-action switching contact, 1 changeover contact
⚠ Single hole fixing limit switches must not be used as an end stop.

Approvals



Mechanical values and environment

Design	Thread M12 x 1
--------	----------------

Housing material	Stainless steel
Ambient temperature	-30 ... +85 °C
Degree of protection	IP65
Mechanical life	1 x 10 ⁶
Contact material	Silver alloy, gold-plated
Switching principle	Snap-action switching contact
Repeat accuracy (absolute)	±0,01 mm [1]
Installation position	Any
Number of NC contacts	1 [2]
Number of NO contacts	1 [3]
Connection	Silicone cable [4]
Cable length	1,2 m
Approach speed	0,01 ... 8 m/min
Actuating element	Domed plunger [5]
Actuating force	Approx. 16 N

Electrical connection ratings

Utilization category according to EN 60947-5-1	
AC-15	0.5A 230V
DC-13	0.6A 24V
Short circuit protection according to IEC 60269-1	2A gG
Rated insulation voltage U _i	250 V
Rated impulse withstand voltage U _{imp}	2,5 kV
Switching voltage	
min.	12 V
Switching current	
Min. at 24V	10 mA
Connection cross-section	0,5 mm ²

Miscellaneous

C number	
C2463	Domed plunger

[1] On axial actuation in the retracted state after approx. 2000 operating cycles

[2, 3] Changeover contact

[4] Three-core

[5] Short

Dimension drawing

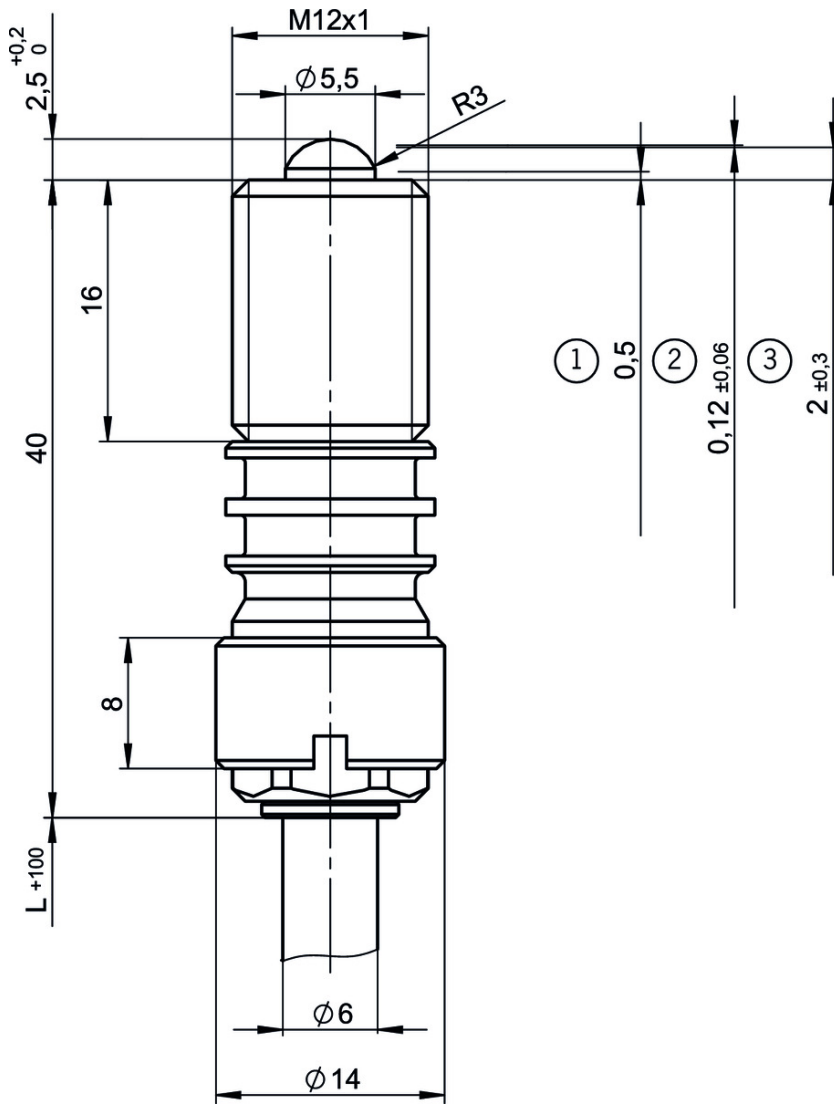





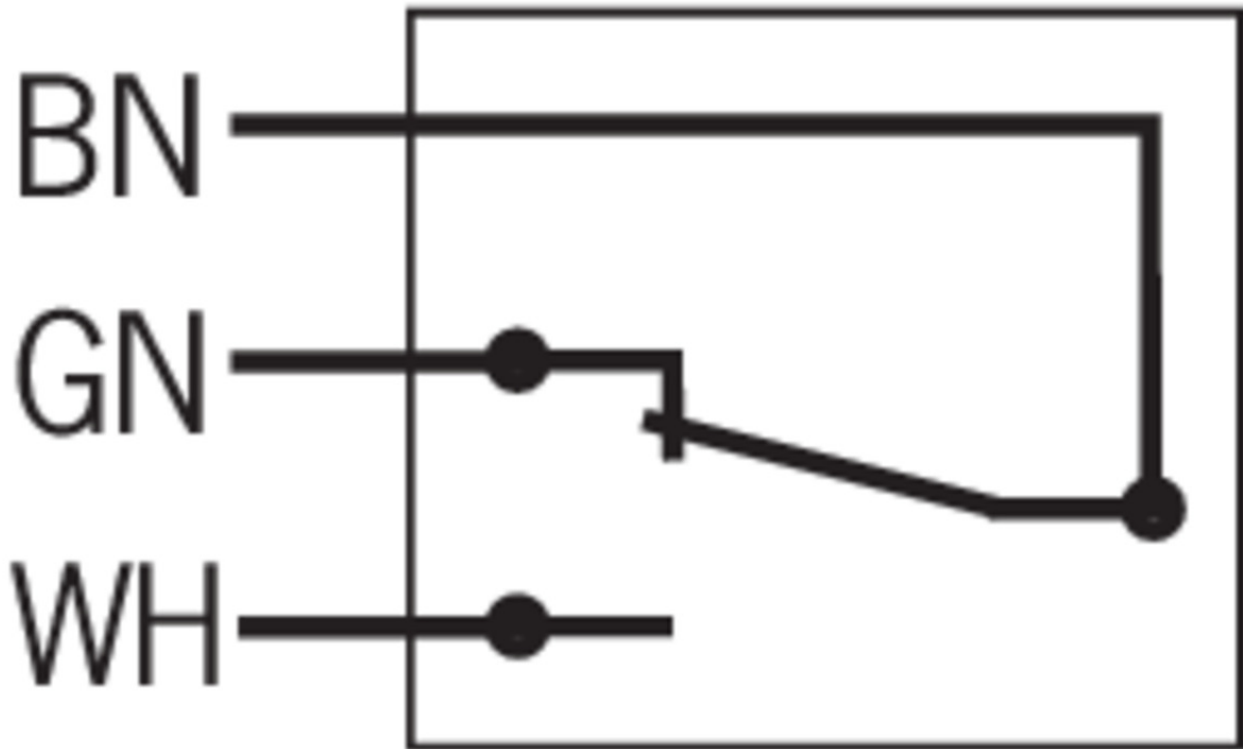

Legende

- 1 End position
- 2 Differential travel
- 3 Operating point



Catalogs

- ▼ Positionsschalter und Reihengrenztaster Position Switches and Multiple Limit Switches
 Interrupteurs de position et boîtiers multipistes

	Doc. no.	Version	Language	Download
Positionsschalter und Reihengrenztaster	157835	01-03/18		 4.1 MB
Interrupteurs de position et boîtiers multipistes	157837	01-03/18		 4.1 MB
Position Switches and Multiple Limit Switches	157836	01-03/18		 4.1 MB