

ITEM 137748 MSM-1-P-CA-L00-C1-137748

Description	Technical data	Accessories	Downloads
-------------	----------------	-------------	-----------



Features

- › Function expansion for modules MGB2 and MCM
- › Connection type: P
- › White cover for indicators, top/bottom

Approvals



Mechanical values and environment

Material	Fiber glass reinforced plastic
Weight	Net 0,1 kg
Ambient temperature	At $U_B = 24V DC$ -25 ... 55 °C

Degree of protection	IP 65 (IP 20) ^[1]
Resilience to vibration	In acc. with EN 60947-5-3
Installation position	Any

Electrical connection ratings

	Controls and indicators
Switching voltage	24 V
Switching current	5 ... 10 mA
Breaking capacity	max.0,25 W
Power supply LED	24 V DC

Controls and indicators

Control/indicator	
Version	Cover for indicators
Color	white
Item	S1

^[1] IP 65: Only in the screwed tight state with the specified base modules.

Dimension drawing

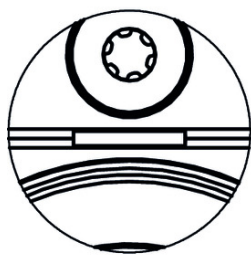

Z 2:1

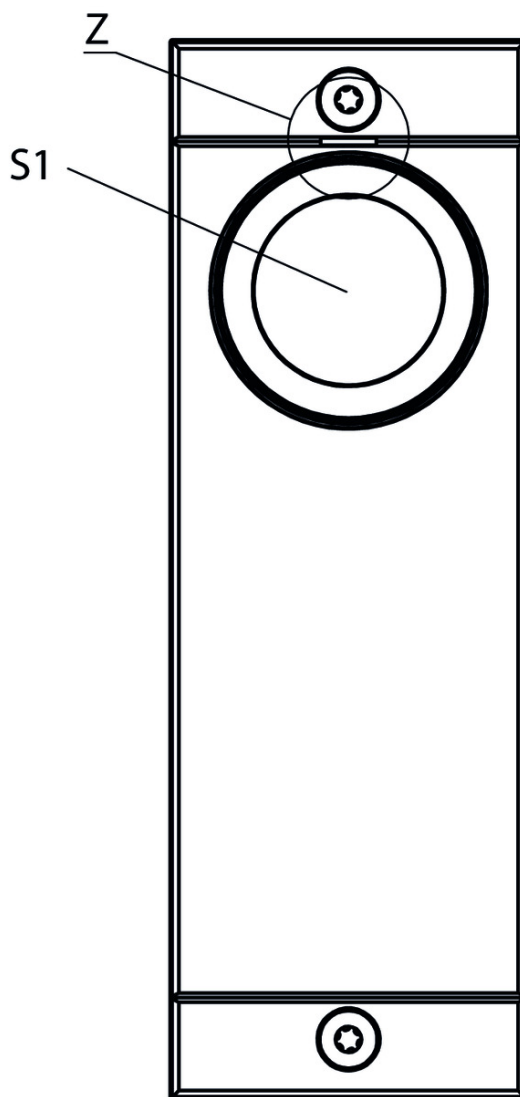

Legende

R Marks position of S1





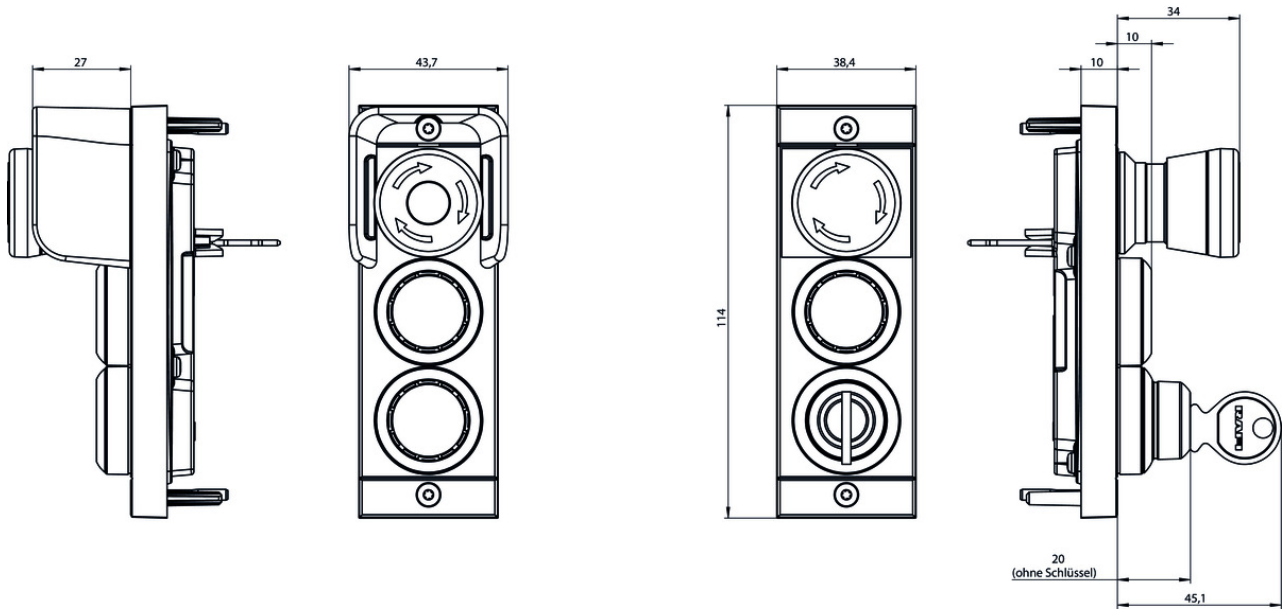



S1 Cover for indicators, white

Dimension drawing



Catalogs

Multifunctional Gate Box MGB2 Modular Multifunctional Gate Box MGB2 Modular Multifunctional Gate Box MGB2 Modular Multifunctional Gate Box MGB2 Modular

	Doc. no.	Version	Language	Download
Multifunctional Gate Box MGB2 Modular	159037	02-09/18		 14.3 MB
Multifunctional Gate Box MGB2 Modular	159050	02-09/18		 14.4 MB
Multifunctional Gate Box MGB2 Modular	159051	02-09/18		 14.4 MB
Multifunctional Gate Box MGB2 Modular	159039	02-09/18		 14.4 MB