

ITEM 156381 MGB2-L2-MLI-U-YB1A1-DA-L-156381

Description	Technical data	Accessories	Downloads
-------------	----------------	-------------	-----------



Features

- › Guard locking for protection of persons or processes
- › Locking module MGB2 for connection to a bus module MBM
- › Locking with monitored guard locking
- › Category 4/PL e for the evaluation of all safety functions
- › One illuminated emergency stop according to ISO 13850
- › Two illuminated pushbuttons
- › Three cut-outs for slide-in labels
- › Adjustable door hinge; factory setting: left
- › Unicode
- › Compatible with all Modular devices

Guard locking type

MGB2- Guard locking by solenoid force. Activation of the guard locking by applying voltage to the guard locking solenoid. (Open-circuit current principle)

Door hinge

On the locking modules, the door hinge can be changed from right to left and vice versa at any time with little effort.

Lens set

The color of the pushbuttons can be selected using the lens set 120344 included (five colors).

Slide-in labels

The user can produce custom labeling using the enclosed slide-in labels (three, blank)

Approvals



Components included in the set



156392 Locking module MGB2-L2-MLI-U-Y0000-BJ-156392
Features



137610 Submodule MSM-1-N-AA-QQQ-B1-137610
Features



136687 Submodule MSM-1-P-CA-BPP-A1-136687
Features



156718 AC-MC-00-0-B-156718
Features



157024 Module connector AC-MC-SB-M-A-157024
Features

Mechanical values and environment

Installation position

Door hinge DIN left

Miscellaneous

Additional feature

Incl. cover set ID. No. 120344

Slide-in label

3 pc. without marking

Reliability values acc. to EN ISO 13849-1

Evaluation of safety signals in included submodules

Category	4
Performance Level	PL e
PFH _D	7.212 x 10 ⁹

Dimension drawing

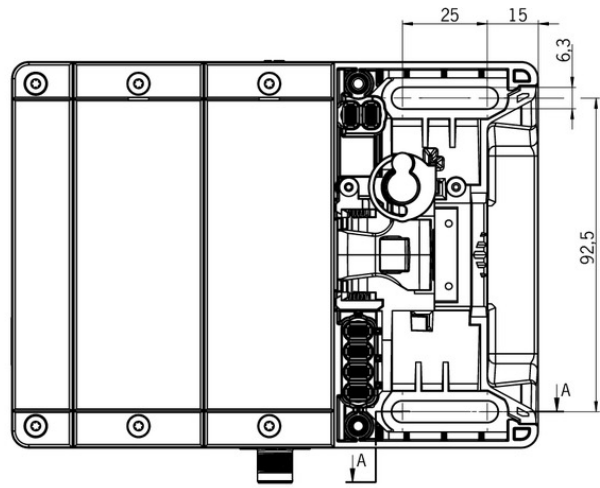
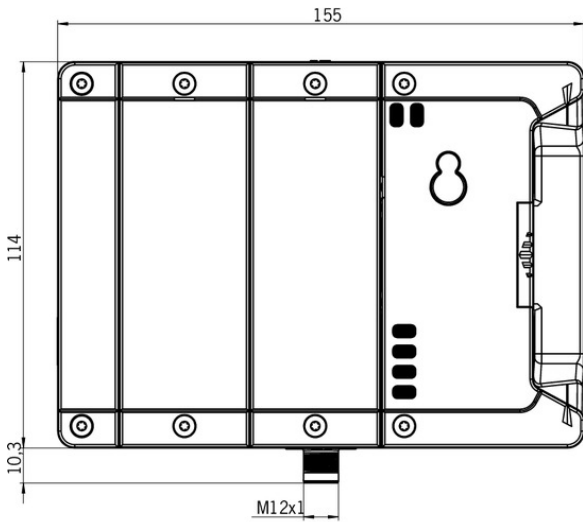

A- A

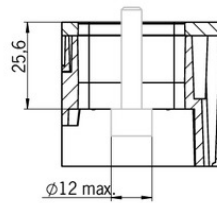
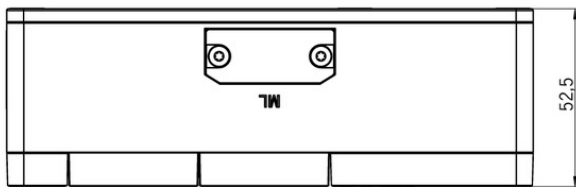

Dimension drawing

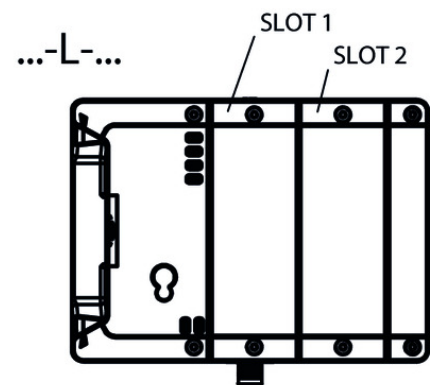
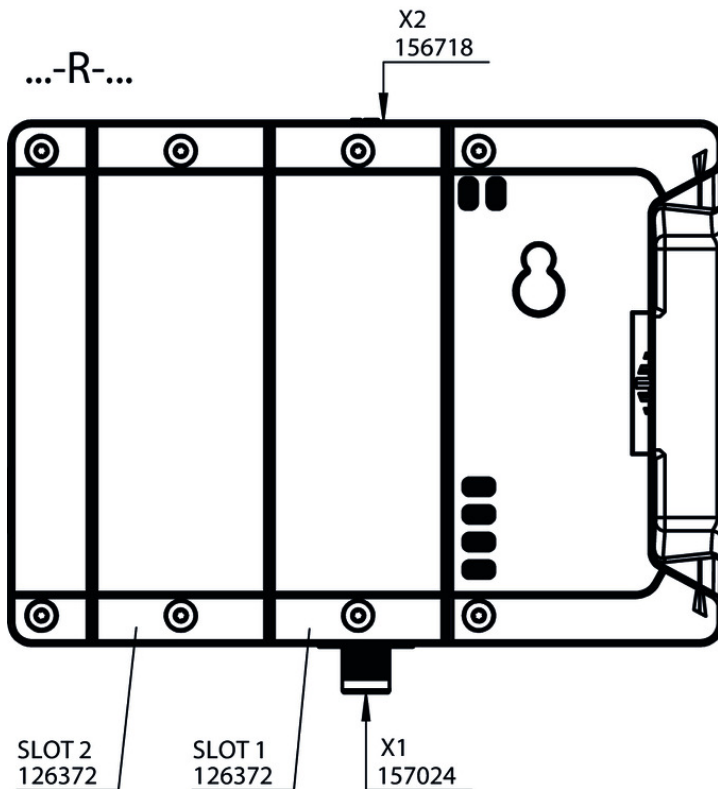

Miscellaneous accessories

✓ Lens set 6 colors



120378 AY-SET-LNS-0002-120378

✓ Lens set 5 colors



120344 AY-SET-LNS-0001-120344

✓ Lens set labeled



120377 AY-SET-LNS-SY01-120377



126158 AY-SET-LNS-SY03-126158



125359 AY-SET-LNS-SY02-125359

✓ Adhesive labels

114529 MGB-A-PLATESET-NN01-114529

- ▼ Features
 - › Adhesive labels suitable for MGB evaluation modules, bus modules and control modules
 - › silver, blank
 - › Packaging unit = 10 pcs.
-

Submodules

- ▼ Submodule MSM-1-P-CA-BPP-A1 (illuminated emergency stop, two illuminated pushbuttons)



136687 MSM-1-P-CA-BPP-A1-136687

- ▼ Features
 - › Function expansion for modules MGB2 and MCM
 - › Connection type: P
 - › One illuminated emergency stop according to ISO 13850
 - › Two illuminated pushbuttons
 - › incl. lens set
-

- ▼ Submodule MSM-1-P-CA-B0P-B5 (illuminated emergency stop, illuminated pushbutton)



137738 MSM-1-P-CA-B0P-B5-137738

- ▼ Features
 - › Function expansion for modules MGB2 and MCM
 - › Connection type: P
 - › One illuminated emergency stop according to ISO 13850
 - › One illuminated pushbutton
 - › incl. lens set
-

- ▼ Submodule MSM-1-P-CS-BPP-A5 (illuminated emergency stop with protection, two illuminated pushbuttons)



126381 MSM-1-P-CS-BPP-A5-126381

- ▼ Features
 - › Function expansion for modules MGB2 and MCM
 - › Connection type: P
 - › One illuminated emergency stop according to ISO 13850
 - › Two illuminated pushbuttons
 - › incl. lens set
-

- ▼ Submodule MSM-1-P-CS-B0P-A2 (illuminated emergency stop with protection, illuminated pushbutton)



137020 MSM-1-P-CS-B0P-A2-137020

- ▼ Features
 - › Function expansion for modules MGB2 and MCM
 - › Connection type: P
 - › One illuminated emergency stop according to ISO 13850
 - › One illuminated pushbutton
 - › incl. lens set
-

- ▼ Submodule MSM-1-P-CA-PPP-A9 (three illuminated pushbuttons)



127040 MSM-1-P-CA-PPP-A9-127040

✓ Features

- › Function expansion for modules MGB2 and MCM
 - › Connection type: P
 - › Three illuminated pushbuttons
 - › incl. lens set
-

✓ Submodule MSM-1-P-CA-P0P-B6 (two illuminated pushbuttons, top/bottom)



137740 MSM-1-P-CA-P0P-B6-137740

✓ Features

- › Function expansion for modules MGB2 and MCM
 - › Connection type: P
 - › Two illuminated pushbuttons
 - › incl. lens set
-

✓ Submodule MSM-1-P-CA-PP0-B7 (two illuminated pushbuttons, middle, top/bottom)



137742 MSM-1-P-CA-PP0-B7-137742

✓ Features

- › Function expansion for modules MGB2 and MCM
 - › Connection type: P
 - › Two illuminated pushbuttons, middle, top/bottom
 - › incl. lens set
-

✓ Submodule MSM-1-P-CA-0P0-B8 (illuminated pushbutton, middle)



137744 MSM-1-P-CA-0P0-B8-137744

✓ Features

- › Function expansion for modules MGB2 and MCM
 - › Connection type: P
 - › One illuminated pushbutton, middle
 - › incl. lens set
-

✓ Submodule MSM-1-P-CA-P00-B9 (illuminated pushbutton, top/bottom)



137746 MSM-1-P-CA-P00-B9-137746

✓ Features

- › Function expansion for modules MGB2 and MCM
 - › Connection type: P
 - › One illuminated white pushbutton, top/bottom
 - › incl. lens set
-

✓ Submodule MSM-1-P-CA-L00-C1 (white cover for indicators, top/bottom)



137748 MSM-1-P-CA-L00-C1-137748

✓ Features

- › Function expansion for modules MGB2 and MCM
 - › Connection type: P
 - › White cover for indicators, top/bottom
-

▼ Submodule MSM-1-P-CA-0L0-A3 (white cover for indicators, middle)



126062 MSM-1-P-CA-0L0-A3-126062

▼ Features

- › Function expansion for modules MGB2 and MCM
 - › Connection type: P
 - › Cover for indicators, white, middle
-

▼ Submodule MSM-1-P-CA-KPP-C3 (one selector switch 90°, form V, illuminated, two illuminated pushbuttons)



137752 MSM-1-P-CA-KPP-C3-137752

▼ Features

- › Function expansion for modules MGB2 and MCM
 - › Connection type: P
 - › One selector switch 1 x 90°, form V, illuminated
 - › Two illuminated pushbuttons
 - › incl. lens set
-

▼ Submodule MSM-1-P-DA-M00-A6 (M12 plug connector for enabling switch)



137596 MSM-1-P-DA-M00-A6-137596

▼ Features

- › Function expansion for modules MGB2 and MCM
 - › Connection type: P
 - › One plug connector M12 for connecting an enabling switch
-

▼ Submodule MSM-1-N-AA-000-A4 (dummy cover)



126372 MSM-1-N-AA-000-A4-126372

▼ Features

- › Function expansion for modules MGB2 and MCM
 - › Connection type: N
 - › Blanking cover
-

▼ Submodule MSM-1-N-AA-QQQ-B1 (blanking cover with three slide-in labels)



137610 MSM-1-N-AA-QQQ-B1-137610

▼ Features

- › Function expansion for modules MGB2 and MCM
 - › Connection type: N
 - › Three cut-outs for slide-in labels
 - › Incl. transparent label holder (AY-C-A1-156732)
 - › Incl. slide-in labels
-

▼ Submodule MSM-1-P-CA-RRR-C5 (three acknowledgment buttons, illuminated)



157218 MSM-1-P-CA-RRR-C5-157218

▼ Features

- › Function expansion for modules MGB2 and MCM
- › Connection type: P

- › Three illuminated acknowledgment buttons

▼ Submodule MSM-1-P-CA-TTT-C7 (three selector switches 1 x 90°, form V, illuminated)



158906 MSM-1-P-CA-TTT-C7-158906

▼ Features

- › Function expansion for modules MGB2 and MCM
- › Connection type: P
- › Three selector switches 1 x 90°, form V, illuminated

Connection material

▼ Module connector MLI (M12), 5-pin, plug



157024 AC-MC-SB-M-A-157024

▼ Features

- › Module plug connector MLI (M12), straight
- › Number of pins: 5-pin , plug

▼ Module connector MLI, 5-pin, socket



157025 AC-MC-SB-F-B-157025

▼ Features

- › Module plug connector MLI, straight
- › Directly pluggable (without thread)
- › Number of pins: 5-pin, socket

▼ Module connector MLI (M12), 5-pin, socket



157028 AC-MC-SB-F-A-157028

▼ Features

- › Module plug connector MLI (M12), straight
- › With thread
- › Number of pins: 5-pin, socket

▼ Cover for unused MLI connections



156718 AC-MC-00-0-B-156718

▼ Features

- › Cover for unused connections
- › incl. fixing screws
- › incl. seal

▼ Connection cable with 2 plug connectors M12, 5-pin, 20m



119971 C-M12F05-05X034PU20,0-M12M05-119971

▼ Features

- › M12 female plug to M12 plug connector, 5-pin
- › Straight female plug and plug connector

- › PUR cable
 - › Cable length 20 m
-

- ▼ Connection cable with 2 plug connectors M12, 5-pin, 10m



119947 C-M12F05-05X034PU10,0-M12M05-119947

▼ Features

- › M12 female plug to M12 plug connector, 5-pin
 - › Straight female plug and plug connector
 - › PUR cable
 - › Cable length 10 m
-

- ▼ Connection cable with 2 plug connectors M12, 5-pin, 5m



119932 C-M12F05-05X034PU05,0-M12M05-119932

▼ Features

- › M12 female plug to M12 plug connector, 5-pin
 - › Straight female plug and plug connector
 - › PUR cable
 - › Cable length 5 m
-

Modules

- ▼ Handle module MGB2-H-BA1A3-L (door handle, with automatic lockout mechanism, door hinge on left)



156394 MGB2-H-BA1A3-L-156394

▼ Features

- › Intelligent bolt tongue
 - › Fold-out lockout mechanism
 - › Second automatically extending lockout mechanism
 - › Door handle
 - › Adjustable door hinge; factory setting: left
-

- ▼ Handle module MGB2-H-BA1A1-L (door handle, door hinge: left)



156396 MGB2-H-BA1A1-L-156396

▼ Features

- › Intelligent bolt tongue
 - › Fold-out lockout mechanism
 - › Door handle
 - › Adjustable door hinge; factory setting: left
-

- ▼ Handle module MGB2-H-BA1A5-L (door handle, with automatic lockout mechanism, door hinge: left)



157020 MGB2-H-BA1A5-L-157020

▼ Features

- › Intelligent bolt tongue
- › Fold-out lockout mechanism
- › Second automatically extending lockout mechanism

- › Door knob
- › Adjustable door hinge; factory setting: left

-
- ▼ Handle module MGB2-H-BA1A8-L (door handle, with automatic lockout mechanism, lockable from the inside when escape release is used, door hinge: left)



157022 MGB2-H-BA1A8-L-157022

▼ Features

- › Intelligent bolt tongue
- › Fold-out lockout mechanism
- › Second automatically extending lockout mechanism
- › Lockable from the inside
- › Door handle
- › Door hinge: left

Function expansion

- ▼ Expansion module MCM-MLI-YA4A4A4A4-JA (with four slots for submodules, one MLI connection)



157774 MCM-MLI-YA4A4A4A4-JA-157774

▼ Features

- › Function expansion for bus module MBM and locking module MGB2-L.-MLI
- › Four slots for mounting submodules
- › Category 4/PL e for the evaluation of all safety functions
- › Four blanking covers
- › Submodule connection type: N/P
- › Compatible with all Modular devices

- ▼ Extension module MCM-MLI-Y00000000-JJ-157854 (open version without submodules, with four slots, one MLI connection)



157854 MCM-MLI-Y00000000-JJ-157854



▼ Features

- › Function expansion for bus module MBM and locking module MGB2-L.-MLI
- › Four slots for mounting submodules
- › Category 4/PL e for the evaluation of all safety functions
- › Open version (without submodules)
- › Submodule connection type: N/P
- › Compatible with all Modular devices

Instructions









- ▼ Betriebsanleitung Verriegelungs-/Zuhaltemodule MGB2-I.-MLI-... / MGB2-L.-MLI-... (Modular) ab V1.00.0

Doc. no. Version Language Download

Betriebsanleitung Verriegelungs-/Zuhaltemodule MGB2-I..-MLI-... / MGB2-L..-MLI-... (Modular) ab V1.00.0	2500234	02-09/18		 4.4 MB
Mode d'emploi Modules de verrouillage / interverrouillage MGB2-I..-MLI-... / MGB2-L..-MLI-... (Modular) et À partir de V1.00.0	2500234	02-09/18		 4.4 MB
Manual de instrucciones Módulos de enclavamiento o bloqueo MGB2-I..-MLI-.../MGB2-L..-MLI-... (Modular) y V1.00.0 o superior	2500234	02-09/18		 4.4 MB
Operating Instructions Interlocking/Locking Modules MGB2-I..-MLI-... / MGB2-L..-MLI-... (Modular) and from V1.00.0	2500234	02-09/18		 4.4 MB

Catalogs

-  Multifunctional Gate Box MGB2 Modular Multifunctional Gate Box MGB2 Modular Multifunctional Gate Box MGB2 Modular Multifunctional Gate Box MGB2 Modular Multifunctional Gate Box MGB2 Modular

	Doc. no.	Version	Language	Download
Multifunctional Gate Box MGB2 Modular	159037	02-09/18		 14.3 MB
Multifunctional Gate Box MGB2 Modular	159050	02-09/18		 14.4 MB
Multifunctional Gate Box MGB2 Modular	159051	02-09/18		 14.4 MB
Multifunctional Gate Box MGB2 Modular	159039	02-09/18		 14.4 MB