

AO000057

ACCESSORIES • MOUNTING

MECHANICAL DATA

Diameter/width of the fastening holes for sensor	3.2 mm
Diameter/width of the fastening holes for sensor	3.2 mm
Height	22 mm
Length	11 mm
Material	Steel
Mounting type	Screw
Number of boreholes	3
Number of oblong holes	1
Surface	Zinc coated
Version	Mounting angle bracket
Weight	70 kg
Width	27 mm

OTHER DATA

Scope of delivery	Angle
-------------------	-------

DIMENSIONAL DRAWING

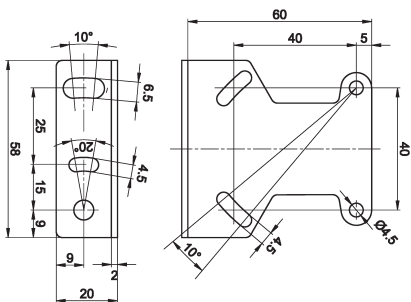

INSTALLATION



Mounting / Installation may only be carried out by a qualified electrician!

DISPOSAL



SAFETY WARNINGS

Before initial operation, please make sure to follow all safety instructions that may be provided in the product information!