

AP000016

ACCESSORIES • MOUNTING



MECHANICAL DATA

Diameter/width of the fastening holes for sensor	4.5 mm
Height	14 mm
Length	40 mm
Material	Aluminium
Mounting type	Screw
Number of boreholes	5
Version	Flange
Weight	36 kg
Width	36 mm

OTHER DATA

Scope of delivery	Mounting material and precision flange
-------------------	--

DIMENSIONAL DRAWING

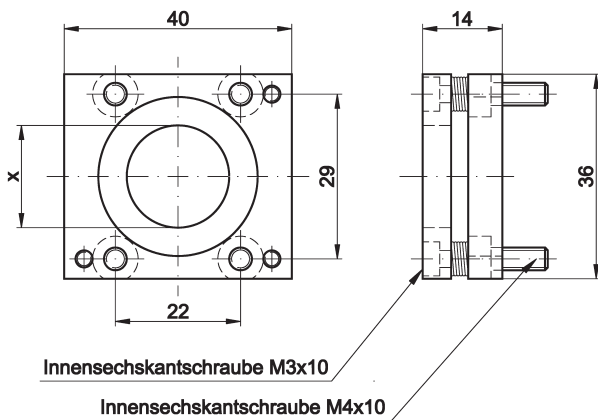

INSTALLATION

DISPOSAL



Mounting / Installation may only be carried out by a qualified electrician!



SAFETY WARNINGS

Before initial operation, please make sure to follow all safety instructions that may be provided in the product information!