

AY000004

ACCESSORIES • MOUNTING



MECHANICAL DATA

For sensor	10mm
Material	Plastic
Mounting type	Screw mounting
Nominal diameter	10 mm
To fix to	Wall mounting

OTHER DATA

Suitable for fire protection areas	No
------------------------------------	----

DIMENSIONAL DRAWING

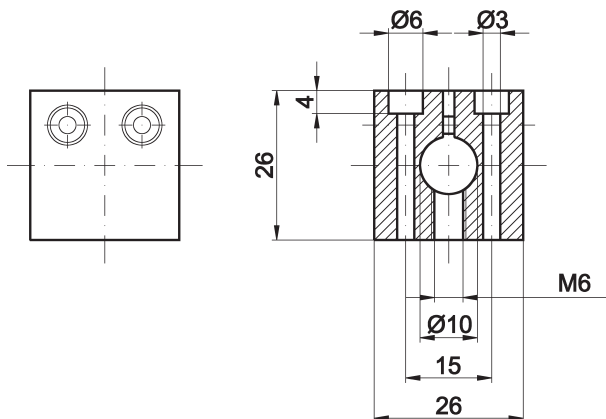

INSTALLATION



Mounting / Installation may only be carried out by a qualified electrician!

DISPOSAL



SAFETY WARNINGS

Before initial operation, please make sure to follow all safety instructions that may be provided in the product information!