

AY000016

ACCESSORIES • MOUNTING



MECHANICAL DATA

For sensor	3mm
Material	Aluminium
Mounting type	Screw mounting
Nominal diameter	3 mm
Surface	Anodised
To fix to	Wall mounting

OTHER DATA

Suitable for fire protection areas	No
------------------------------------	----

DIMENSIONAL DRAWING

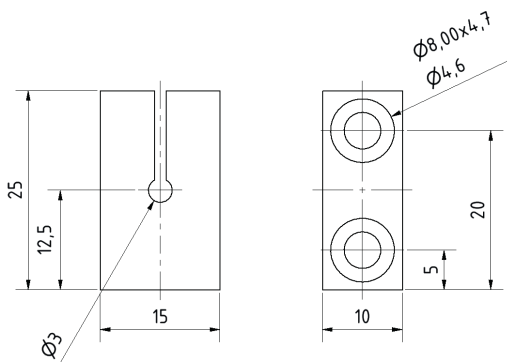

INSTALLATION



Mounting / Installation may only be carried out by a qualified electrician!

DISPOSAL



SAFETY WARNINGS

Before initial operation, please make sure to follow all safety instructions that may be provided in the product information!