

AY000030

ACCESSORIES • HOLDERS FOR STOP TAPPETS



MECHANICAL DATA

Height	14 mm
Length	17 mm
Material	Aluminium
Mounting type	Screw
Number of boreholes	3
Thread pitch	0.5 mm
Thread size, metric	3
Version	Mounting angle bracket
Weight	9 kg
Width	35 mm

OTHER DATA

Scope of delivery	Mounting material for sensor, brackets
-------------------	--

DIMENSIONAL DRAWING

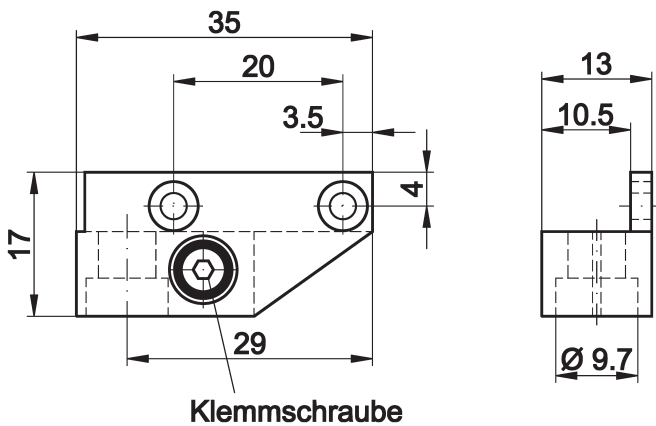

INSTALLATION

DISPOSAL



Mounting / Installation may only be carried out by a qualified electrician!



SAFETY WARNINGS

Before initial operation, please make sure to follow all safety instructions that may be provided in the product information!