

AY000044

ACCESSORIES • MOUNTING



MECHANICAL DATA

For sensor	4mm
Material	Plastic
Material quality	Polyamide PA
Mounting type	Screw mounting
Nominal diameter	4 mm
To fix to	Wall mounting

OTHER DATA

Suitable for fire protection areas	No
------------------------------------	----

DIMENSIONAL DRAWING

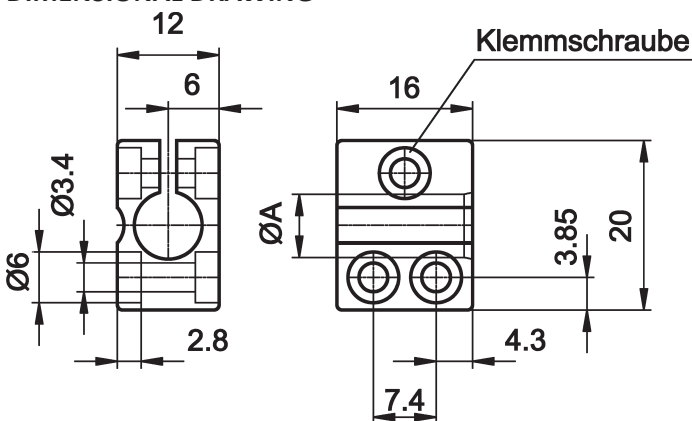

INSTALLATION



Mounting / Installation may only be carried out by a qualified electrician!

DISPOSAL



SAFETY WARNINGS

Before initial operation, please make sure to follow all safety instructions that may be provided in the product information!