

AY000062

ACCESSORIES • MOUNTING



MECHANICAL DATA

For sensor	30mm
Material	Plastic
Material quality	Polyamide PA
Mounting type	Screw mounting
Nominal diameter	30 mm
To fix to	Wall mounting
With positive stop	Yes

OTHER DATA

Suitable for fire protection areas	No
------------------------------------	----

DIMENSIONAL DRAWING

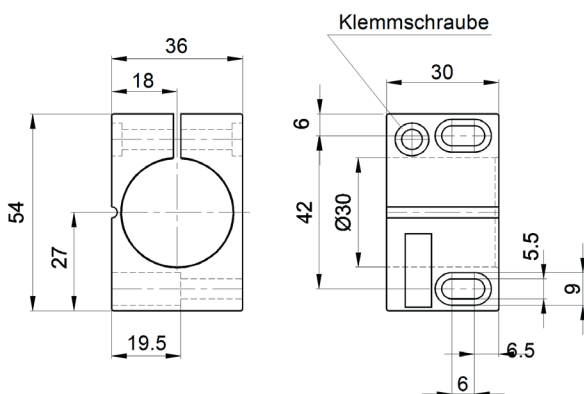

INSTALLATION

DISPOSAL



Mounting / Installation may only be carried out by a qualified electrician!



SAFETY WARNINGS

Before initial operation, please make sure to follow all safety instructions that may be provided in the product information!