

AY000101

ACCESSORIES • MOUNTING



MECHANICAL DATA

Diameter/width of the fastening holes for sensor	6 mm
Height	58 mm
Length	28 mm
Material	Stainless steel
Mounting type	Screw
Number of oblong holes	3
Version	Mounting angle bracket
Weight	66 kg
Width	58 mm

OTHER DATA

Scope of delivery	Toothed washer for sensor, bracket
-------------------	------------------------------------

DIMENSIONAL DRAWING

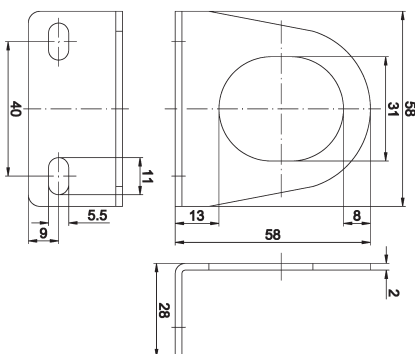

INSTALLATION

DISPOSAL



Mounting / Installation may only be carried out by a qualified electrician!



SAFETY WARNINGS

Before initial operation, please make sure to follow all safety instructions that may be provided in the product information!