



Model Number

ML9-54-G/25/136/115b

Retroreflective sensor
with fixed cable and M12 connector, 4-pin

Features

- Ultra bright LEDs for power on, pre fault indication and switching state
- Flashing power on LED in case of short-circuit
- TEACH-IN
- Automatic adjustment in case of soiling in contrast detection mode
- Not sensitive to ambient light, even with switched energy saving lamps
- Protected against mutual interference (no cross-talk)
- Protection class II

Dimensions

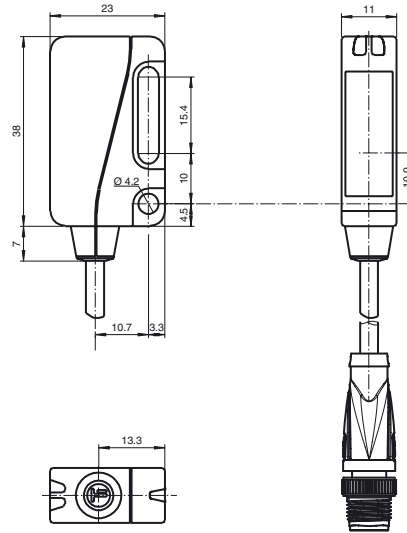

Electrical connection

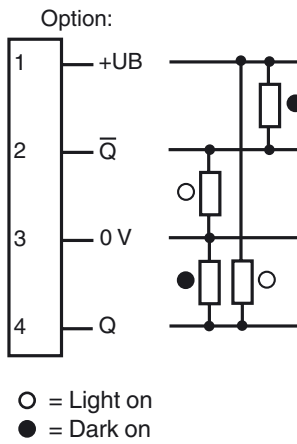

Pinout

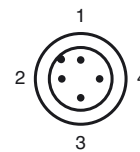

Indicators/operating means

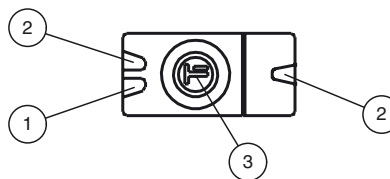

1	LED green
2	LED yellow
3	Teach-In

Release date: 2014-07-21 13:25 Date of issue: 2014-07-21 223658_eng.xml

Technical data**General specifications**

Effective detection range	0 ... 3.5 m in TEACH mode 0 ... 5.7 m in normal mode
Reflector distance	0 ... 3.5 m in TEACH mode 0 ... 5.7 mm in normal mode
Threshold detection range	7.6 m
Reference target	H85-2 reflector
Light source	LED
Light type	modulated visible red light , 660 nm
Polarization filter	yes
Angle deviation	max. $\pm 1^\circ$
Diameter of the light spot	approx. 40 mm at detection range 1 m
Angle of divergence	1.7 °
Ambient light limit	40000 Lux

Functional safety related parameters

MTTF _d	1050 a
Mission Time (T _M)	20 a
Diagnostic Coverage (DC)	0 %

Indicators/operating means

Operation indicator	LED green, statically lit Power on , Undervoltage indicator: Green LED, pulsing (approx. 0.8 Hz) , short-circuit : LED green flashing (approx. 4 Hz)
Function indicator	LED yellow: switching state ; Stability control ; Teach-In
Control elements	Teach-In key
Contrast detection levels	10 % - clean, water filled PET bottles

Electrical specifications

Operating voltage	U _B	10 ... 30 V DC , class 2
Ripple		max. 10 %
No-load supply current	I ₀	< 20 mA at 24 V DC

Output

Switching type	light on	
Signal output	2 push-pull (4 in 1) outputs, complementary, short-circuit proof, reverse polarity protected	
Switching voltage	max. 30 V DC	
Switching current	max. 100 mA	
Switching frequency	f	1000 Hz
Response time		500 μs

Ambient conditions

Ambient temperature	-20 ... 60 °C (-4 ... 140 °F)
Storage temperature	-40 ... 75 °C (-40 ... 167 °F)

Mechanical specifications

Degree of protection	IP67
Connection	200 mm connecting cable with 4-pin, M12x1 connector
Material	
Housing	PC (glass-fiber-reinforced Makrolon)
Optical face	glass
Mass	approx. 25 g

Compliance with standards and directives

Standard conformity	
Product standard	EN 60947-5-2:2007 IEC 60947-5-2:2007
Standards	EN 50178, UL 508

Approvals and certificates

Protection class	II, rated voltage ≤ 50 V AC with pollution degree 1-2 according to IEC 60664-1 functional insulation acc. to DIN EN 50178
UL approval	cULus
CCC approval	CCC approval / marking not required for products rated ≤ 36 V

Accessories**OMH-ML9**

Mounting bracket

OMH-ML9-01

Threaded bolt M3

V1-G-2M-PUR

Female cordset, M12, 4-pin, PUR cable

V1-W-2M-PUR

Female cordset, M12, 4-pin, PUR cable

V1-G-5M-PUR

Female cordset, M12, 4-pin, PUR cable

V1-W-5M-PUR

Female cordset, M12, 4-pin, PUR cable

Other suitable accessories can be found at www.pepperl-fuchs.com

Curves/Diagrams

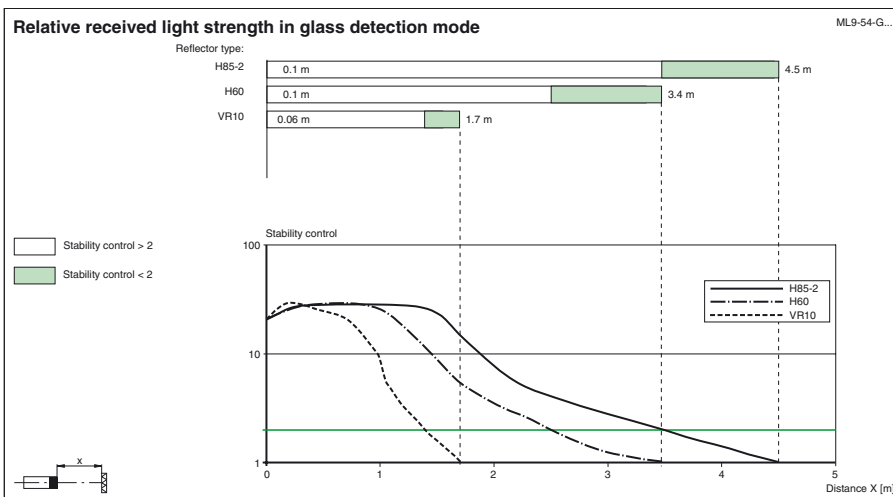
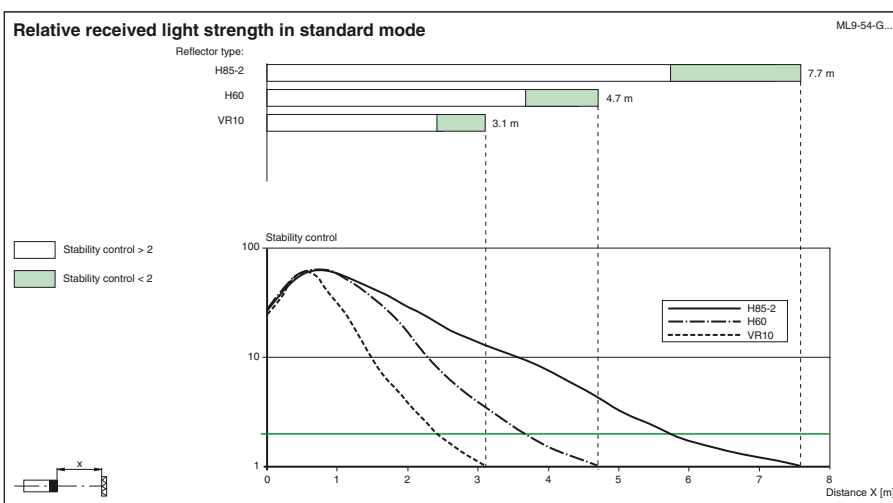
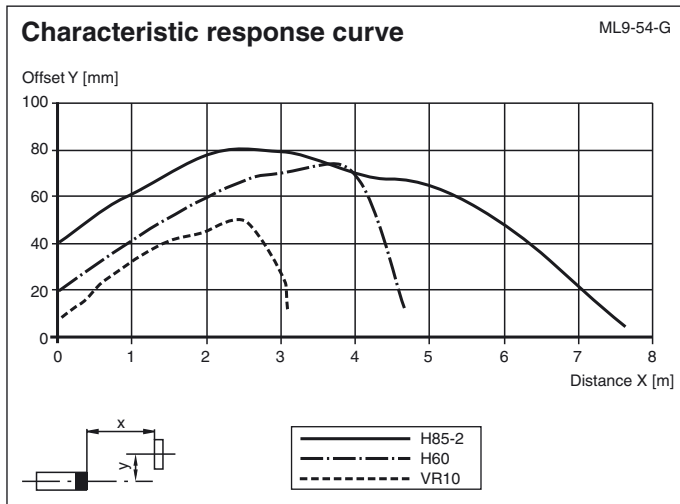

Release date: 2014-07-21 13:25 Date of issue: 2014-07-21 223658_eng.xml

Adjustment instructions

Adjustment instructions for devices with Teach-In

After the operating voltage has been applied, the LED is lit green. The sensor is automatically set to a state of maximum sensitivity (state as supplied) or the state of the most recent Teach-In setting.

Assemble the appropriate reflector opposite the light barrier.

Teach-In using the Teach key

- Align the sensor to an appropriate reflector.
- Press the Teach key - as confirmation, the green display LED is briefly turned off once.

Refer to "General Notes Relating to Pepperl+Fuchs Product Information".

- Hold the Teach key down until the yellow and green display LED is flashing at regular intervals (about 2.5 Hz). Then release the Teach key.
- During the internal set-up of the sensor, the green and yellow display LEDs flash alternately (about 2.5 Hz).
- Teach-In successful: The green and yellow display LEDs are lit. Contrast detection 10% is activated. The device is ready for operation.
- Teach-In not successful: The green and yellow display LEDs flash alternately and rapidly (about 8 Hz) for about 5 seconds. Then the sensor goes to the state with maximum sensitivity. After this happens, repeat the Teach-In procedure, starting with step 1.