

## Datasheet - IFL 20-333E-10

Inductive proximity switch / Housing construction form: Block / IFL 333E



- Design 333 E
- Thermoplastic enclosure
- AC 2-wire
- Double-insulated 

(Minor differences between the printed image and the original product may exist!)

### Ordering details

Product type description	IFL 20-333E-10
Article number	101085116
EAN Code	4030661018843
eCl@ss	27-27-01-01

### Approval

Approval



CCC

### Global Properties

Permanent light	IFL - 333 E
Standards	IEC/EN 60947-5-2; DIN VDE 0660-208
Compliance with the Directives (Y/N) 	Yes
Operating resource protection class	Protection class 2
Materials	
- Material of the housings	Plastic
- Material of the cable mantle	PVC
- Material of the active surface	Plastic
Housing construction form	Block
Weight	134

## Mechanical data

---

Design of electrical connection	Cable H03VV-F
Cable length	2
Conductor with strain relief	No
Conductors	2 x 0,5
mechanical installation conditions	not flush
Switch distance $S_n$	21.5 mm
Reduction factor 1 met (Y/N)	No
Protection circuit	inductive interference protection
Pressure resistant (Y/N)	No

## Ambient conditions

---

Ambient temperature	
- Min. environmental temperature	-25
- Max. environmental temperature	+70
Protection class	IP67 to IEC/EN 60529

## Electrical data

---

Design of control element	Normally open contact (NO)
Number of wire	2
Voltage type	AC, alternating current
Supply voltage $U_B$	
- Min. supply voltage	15
- Max. supply voltage	250
Rated supply frequency	45 ... 65
Switch frequency	approx. 10 HZ
Voltage drop $U_d$	approx. 4.5 V (250 V / 200 mA)
Rated impulse withstand voltage $U_{imp}$	4 kV
Residual current $I_r$	1 mA
Minimum operating current $I_m$	10 mA
Operating current $I_e$	500 mA

## Outputs

---

Design of control output	Two-wire
--------------------------	----------

## LED switching conditions display

---

LED switching conditions display (Y/N)	Yes
- yellow LED	

## ATEX

---

Explosion protection categories for gases	None
Explosion protected category for dusts	None

## Dimensions

---

Dimensions of the sensor	
- Width of sensor	36.5

- Height of sensor	36.5
- Length of sensor	36.5

## notice

---



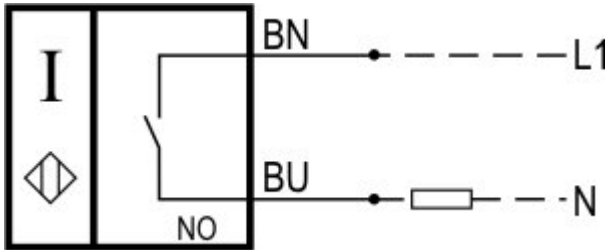

Mounting angle HWE-1 to simplify mounting available

## Diagram

---



Note Diagram

-  positive break NC contact
-  active
-  no active
-  Normally-open contact
-  Normally-closed contact

## Ordering code

---

IFL (1)-(2)-(3)(4)(5)

(1)	
15	Switch distance 15 mm
20	Switch distance 20 mm
(2)	
333E	Block Design, 36,5 x 36,5 x 36,5 mm
(3)	
01	Opener (NC)
10	Normally open contact (NO)
10/01	Normally open contact (NO) / Opener (NC) with Wiring compartment
11	Normally open contact (NO) / Opener (NC) antivalent
(4)	
Z	Protection class IP67
(5)	
N	n-type
P	p-type

## Documents

---

**Operating instructions** (nl) 134 kB, 01.08.2018

Code: mrl\_ifl-allgemein\_nl

**Operating instructions** (en) 128 kB, 31.08.2016

Code: mrl\_ifl-allgemein\_en

**Operating instructions** (pl) 137 kB, 21.10.2016

Code: mrl\_ifl-allgemein\_pl

**Operating instructions** (pt) 109 kB, 06.04.2017

Code: mrl\_ifl-allgemein\_pt

**Operating instructions** (it) 108 kB, 21.10.2016

Code: mrl\_ifl-allgemein\_it

**Operating instructions** (es) 110 kB, 21.10.2016

Code: mrl\_ifl-allgemein\_es

**Operating instructions** (cn) 177 kB, 05.05.2017

Code: mrl\_ifl-allgemein\_cn

**Operating instructions** (de) 131 kB, 31.08.2016

Code: mrl\_ifl-allgemein\_de

**Operating instructions** (fr) 110 kB, 21.10.2016

Code: mrl\_ifl-allgemein\_fr

**Declaration of conformity** (en) 91 kB, 13.04.2017

Code: konfi\_ifl\_en

**Declaration of conformity** (de) 96 kB, 01.07.2016

Code: konfi\_ifl\_de

**CCC certification** (en) 4 MB, 11.07.2018

Code: q\_iflp01

**CCC certification** (cn) 4 MB, 11.07.2018

Code: q\_iflp04

## Images

---

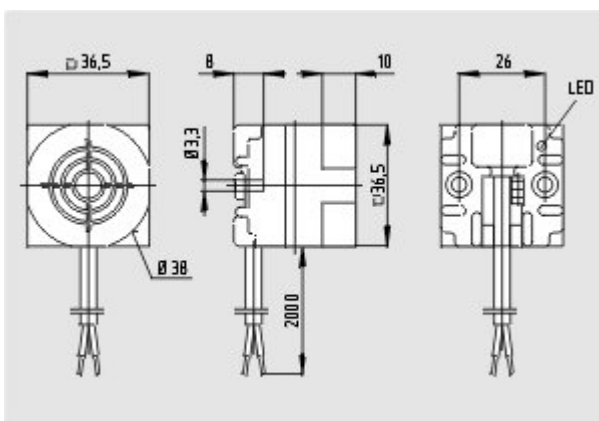

Dimensional drawing (basic component)

---

K.A. Schmersal GmbH & Co. KG, Möddinghofe 30, D-42279 Wuppertal

The data and values have been checked thoroughly. Technical modifications and errors excepted.

Generiert am 13.02.2019 - 13:06:09h Kasbase 3.3.0.F.64I