

## Datasheet - CSS 8-180-2P-Y-L

Safety sensors / CSS 180



Preferred typ



(Minor differences between the printed image and the original product may exist!)

- 2 x Pre-wired cable 4-pole
- Thermoplastic enclosure
- Electronic contact-free, coded system
- Misaligned actuation possible
- High repeat accuracy of the switching points
- Max. length of the sensor chain 200 m
- Early warning when operating near the limit of the sensor's hysteresis range
- Self-monitoring series-wiring of 16 sensors
- 2 short-circuit proof PNP safety outputs

### Ordering details

Product type description	CSS 8-180-2P-Y-L
Article number	101165294
EAN Code	4030661208787
eCl@ss	27-27-24-01

### Approval

Approval

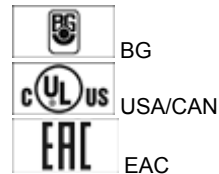

### Classification

Standards	EN ISO 13849-1, IEC 61508, IEC 60947-5-3
PL	up e
Control category	bis 4
PFH	2.5 x 10 <sup>-9</sup> / h
SIL	bis 3
Mission time	20 Years
Classification	PDF-M

### Global Properties

Permanent light	CSS 180
Standards	IEC 61508, IEC 60947-5-3
Compliance with the Directives (Y/N)	Yes
Suitable for safety functions (Y/N)	Yes
Function	Sensor for series wiring
Series-wiring	up to 16 components

Length of the sensor chain	max. 200 m
Active principle	inductive
Materials	
- Material of the housings	Plastic, glass-fibre reinforced thermoplastic
- Material of the nuts	Plastic, glass-fibre reinforced thermoplastic
- Material of the active surface	Plastic, glass-fibre reinforced thermoplastic
Housing construction form	cylinder, thread
Cable colour	Grey ( OUT), Black ( IN)
Weight	167
Reaction time	≤ 30
Duration of risk	≤ 30
Cascadable (Y/N)	Yes
Recommended actuator	CST 180-1, CST 180-2

## Mechanical data

---

Design of electrical connection	Cable
- Connector OUT	4-pole
- Connector IN	4-pole
Cable length	2 ( OUT), 0,25 ( IN)
AWG-Number	
mechanical installation conditions	not flush
Switch distance $S_n$	8 mm
Ensured switch distance ON $S_{ao}$	7 mm
Ensured switch distance OFF $S_{ar}$	10 mm
hysteresis	≤ 0,7 mm
Repeat accuracy $R_R$	≤ 0,2 mm
restistance to shock	30 g / 11 ms
Resistance to vibration	10 ... 55 HZ, Amplitude 1 mm
Tightening torque for nuts	A/F 24 max. 300 Ncm

## Ambient conditions

---

Ambient temperature	
- Min. environmental temperature	-25
- Max. environmental temperature	+60
Storage and transport temperature	
- Min. Storage and transport temperature	-25
- Max. Storage and transport temperature	+85
Protection class	IP65, IP67 to IEC/EN 60529
Protection rating	II
Air clearances and creepage distances To IEC/EN 60664-1	
- Rated impulse withstand voltage $U_{imp}$	0,8 kV
- Overvoltage category	III
- Degree of pollution	3

## Electrical data

---

Cross circuit/short circuit recognition possible (Y/N)	Yes
Voltage type	DC
Supply voltage $U_B$	
- Min. supply voltage	20.4 V DC
- Max. supply voltage	26.4 V DC
Switch frequency	3

Rated insulation voltage $U_i$	32 V DC
Residual current $I_r$	$\leq 0,5$ mA
Operating current $I_e$	1 A
Utilisation category	DC-12: 24 V / 0,5 A DC-13: 24 V / 0,5 A
No-load current $I_0$	0,05 A

### Electrical data - Safety inputs

---

Safety inputs	X1 and X2
---------------	-----------

### Electrical data - Safety outputs

---

Safety outputs	Y1 and Y2
Fuse rating	short-circuit proof, p-type
Design of control output	PNP
Number of secure semi-conductor outputs	2
Max. output current at secured output	0,5 A
Rated operating voltage	24 VDC
Operating current $I_e$	0,5 A
Utilisation category	DC-12: 24 V / 0,5 A DC-13: 24 V / 0,5 A
Voltage drop $U_d$	max. 0,5 V

### Electrical data - Diagnostic output

---

Number of semi-conductor outputs with signaling function	0
--	---

### LED switching conditions display

---

LED switching conditions display (Y/N)	Yes
Multi-coloured LED	green, red, yellow

### ATEX

---

Explosion protection categories for gases	None
Explosion protected category for dusts	None

### Dimensions

---

Dimensions of the sensor	
- Length of sensor	92
- Diameter of sensor	M18

### Pin assignment

---

1 - A1 Ue	Brown
2 - Y2 Safety output 2, X2 Safety input 2	White
3 - A2 GND	Blue
4 - Y1 Safety output 1, X1 Safety input 1	Black

### notice

---

Requirements for the safety monitoring module

2-channel safety input, suitable for p-type sensors with NO function. The

safety monitoring module must tolerate internal functional tests of the sensors with cyclic switch-off of the sensor outputs for max. 2 ms. The safety monitoring module does not need to have a cross-wire short monitoring function.

## Included in delivery

---

Actuators must be ordered separately.

Mounting accessories

2 x Nuts M 18 x 1

## Indication legend

---

see drawing: Characteristic curve



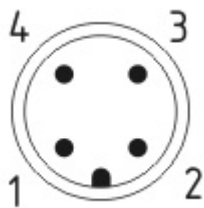

S	Switch distance
V	Axial offset
S <sub>on</sub>	Switch-on distance
S <sub>off</sub>	Switch-off distance
S <sub>h</sub>	Hysteresis area
S <sub>ao</sub>	Ensured switch distance ON
S <sub>ar</sub>	Ensured switch distance OFF

## Diagram

---



Note Diagram

-  positive break NC contact
-  active
-  no active
-  Normally-open contact
-  Normally-closed contact

## Ordering code

---

CSS 8-180-(1)-(2)-(3)

(1)

2P

2P+D

(2)

E

Y

M

(3)

L

LST

ST

2 short-circuit proof PNP safety outputs

2 short-circuit proof PNP safety outputs and Diagnostic output

Individual sensor or end sensor in a series

Series-wiring

Multifunction connection

cable

cable with connector

connector plug

## Documents

---

**Operating instructions and Declaration of conformity** (en) 288 kB, 07.03.2017

Code: mrl\_css180\_en

**Operating instructions and Declaration of conformity** (it) 299 kB, 29.06.2017

Code: mrl\_css180\_it

**Operating instructions and Declaration of conformity** (fr) 296 kB, 28.04.2017

Code: mrl\_css180\_fr

**Operating instructions and Declaration of conformity** (pl) 315 kB, 04.07.2017

Code: mrl\_css180\_pl

**Operating instructions and Declaration of conformity** (es) 294 kB, 28.04.2017

Code: mrl\_css180\_es

**Operating instructions and Declaration of conformity** (jp) 377 kB, 15.01.2013

Code: mrl\_css180\_jp

**Operating instructions and Declaration of conformity** (cn) 502 kB, 23.11.2018

Code: mrl\_css180\_cn

**Operating instructions and Declaration of conformity** (nl) 337 kB, 05.07.2018

Code: mrl\_css180\_nl

**Operating instructions and Declaration of conformity** (da) 297 kB, 23.08.2012

Code: mrl\_css180\_da

**Operating instructions and Declaration of conformity** (pt) 299 kB, 05.04.2017

Code: mrl\_css180\_pt

**Operating instructions and Declaration of conformity** (de) 279 kB, 07.03.2017

Code: mrl\_css180\_de

**Wiring example** (de) 55 kB, 29.09.2009

Code: kcsp1p01

**Diagnosis tables** (en) 136 kB, 12.01.2009

Code: b\_tabp02

**Diagnosis tables** (de) 135 kB, 12.01.2009

Code: b\_tabp01

**BG-test certificate** (de) 224 kB, 20.11.2015

Code: z\_cssp01

**BG-test certificate** (en) 196 kB, 10.12.2015

Code: z\_cssp02

**Brochure** (de) 6 MB, 15.02.2018

Code: b\_css\_brosch09\_de

**Brochure** (en) 6 MB, 15.02.2018

Code: b\_css\_brosch09\_en

**Brochure** (en) 517 kB, 03.05.2005

Code: b\_cssp02

Brochure (de) 520 kB, 03.05.2005

Code: b\_cssp01

EAC certification (ru) 747 kB, 05.10.2015

Code: q\_6396p17\_ru

## Images

---

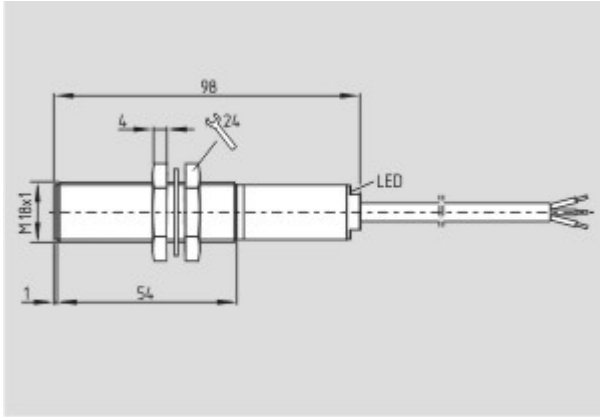

Dimensional drawing (basic component)

---

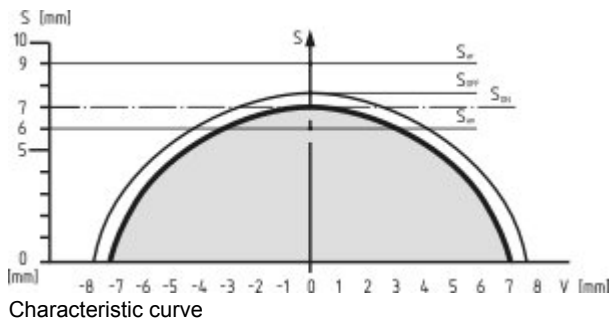

Characteristic curve

---

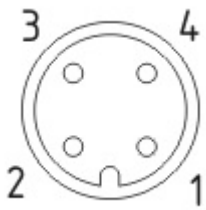

Contact arrangement

---



Wiring diagram

---

## System components

---

### Actuator



#### 101179574 - CST 180-2

- Front and lateral actuation of the sensor possible



#### 101177198 - CST 180-1

- Front and lateral actuation of the sensor possible

### Accessories



#### 101173457 - CSA-M-1

- Magnetic snap lock
- For play-free interlocking of light guards

### Safety control modules



#### SRB031MC

- 1 Signalling output
- 3 safety contacts, STOP 1
- Drop-out delay can be set between 0,4 to 1,5 s
- Suitable for signal processing of potential-free outputs, e.g. emergency stop command devices, position switches and solenoid interlocks
- Suitable for signal processing of outputs connected to potentials (AOPDs), e.g. safety light grids/curtains
- Fit for signal evaluation of outputs of safety magnetic switches



#### SRB 301LC/B

- Fit for signal evaluation of outputs of safety magnetic switches (to this end, integrated current and voltage limiters)
- Suitable for signal processing of potential-free outputs, e.g. emergency stop command devices, position switches and solenoid interlocks
- Suitable for signal processing of outputs connected to potentials (AOPDs), e.g. safety light grids/curtains
- 3 safety contacts, STOP 0
- 1 Signalling output



#### SRB 301MC

- Fit for signal evaluation of outputs of safety magnetic switches
- 3 safety contacts, STOP 0
- 1 Signalling output
- Suitable for signal processing of outputs connected to potentials (AOPDs), e.g. safety light grids/curtains
- Suitable for signal processing of potential-free outputs, e.g. emergency stop command devices, position switches and solenoid interlocks

---

#### SRB301ST



- Suitable for signal processing of potential-free outputs, e.g. emergency stop command devices, position switches and solenoid interlocks
- Suitable for signal processing of outputs connected to potentials (AOPDs), e.g. safety light grids/curtains
- Fit for signal evaluation of outputs of safety magnetic switches
- 3 safety contacts, STOP 0
- 1 Signalling output



#### **SRB304ST**

- Suitable for signal processing of potential-free outputs, e.g. emergency stop command devices, position switches and solenoid interlocks
- Suitable for signal processing of outputs connected to potentials (AOPDs), e.g. safety light grids/curtains
- Fit for signal evaluation of outputs of safety magnetic switches
- 3 safety contacts, STOP 0
- 4 Signalling outputs



#### **SRB324ST**

- Suitable for signal processing of potential-free outputs, e.g. emergency stop command devices, position switches and solenoid interlocks
- Suitable for signal processing of outputs connected to potentials (AOPDs), e.g. safety light grids/curtains
- 3 safety contacts, STOP 0;  
2 safety contacts, STOP 1 (adjustable 1 ... 30 s)
- 4 Signalling outputs
- Optional: Short-circuit recognition, Manual reset with edge detection in fail-safe circuit, Automatic reset function



#### **101170036 - AES 1135**

- Monitoring of BNS range magnetic safety sensors
- 1 safety contact, STOP 0
- 2 Signalling outputs



#### **101170049 - AES 1235**

- Monitoring of BNS range magnetic safety sensors
- 2 safety contacts, STOP 0
- 2 Signalling outputs

### **Mounting accessories**



#### **101068879 - MOUNTING CLAMP H 18**

- For a smooth fitting of the proximity switches with cylindric shape  $\varnothing$  18 mm or thread M18