

Datasheet - Z3K 235-11Z

Position switch / 235 Metal enclosure - EN 50047 with Actuator / 235 Angle roller lever 3K



Preferred typ



- Metal enclosure
- Wide range of alternative actuators
- Good resistance to oil and petroleum spirit
- 30 mm x 63,5 mm x 30 mm
- Snap action with constant contact pressure up to switching point
- slim design
- Actuator heads can be repositioned by 4 x 90°
- Mounting details to EN 50047
- 1 Cable entry M 20 x 1.5
- Actuation from bottom parallel to the switch, therefore only suitable for small housings.

(Minor differences between the printed image and the original product may exist!)

Ordering details

Product type description	Z3K 235-11Z
Article number	101165850
EAN Code	4030661212326
eCl@ss	27-27-26-01

Approval

Approval

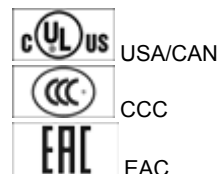

Classification

Standards	ISO 13849-1
B10d Normally-closed contact (NC)	20.000.000
Mission time	20 Years
notice	$MTTF_d = \frac{B_{10d}}{0,1 \times n_{op}}$ $n_{op} = \frac{d_{op} \times h_{cp} \times 3600 \text{ s/h}}{t_{cycle}}$

Global Properties

Permanent light	Z 235 Winkelhebel 3K
Standards	IEC 60947-5-1, ISO 13849-1, BG-GS-ET-15
Compliance with the Directives (Y/N) 	Yes
Suitable for safety functions (Y/N)	Yes
Materials	
- Material of the housings	Zink
- Material of the contacts	Silver
Housing coating	painted
Housing construction form	Norm construction design
Weight	150

Mechanical data

Design of electrical connection	Screw connection
Cable section	
- Min. Cable section	0,75
- Max. Cable section	2.5
Mechanical life	20.000.000 operations
Switching frequency	max. 5000 /h
notice	All indications about the cable section are including the conductor ferrules.
Design of actuating element	Angle roller lever
Actuating force	min. 9 N
Bounce duration	< 3
Switchover time	> 5.5
Positive break force	19 N
Actuating speed with actuating angle 30° to switch axis	
- Min. Actuating speed	27 mm/min
- Max. Actuating speed	1 m/s

Ambient conditions

Ambient temperature	
- Min. environmental temperature	-30 °C
- Max. environmental temperature	+80 °C
Protection class	IP67

Electrical data

Design of control element	Normally open contact (NO), Opener (NC)
Switching principle	Snap switch element
- positive break NC contact 	
Number of auxiliary contacts	1
Number of safety contacts	1
Rated impulse withstand voltage U_{imp}	6 kV
Rated insulation voltage U_i	500 V
Thermal test current I_{the}	10 A
Utilisation category	AC-15: 230 V / 4 A, DC-13: 24 V / 1 A
Required rated short-circuit current	1000 A
Max. fuse rating	6 A gG D-fuse

ATEX

Explosion protection categories for gases	None
Explosion protected category for dusts	None

Dimensions

Dimensions of the sensor

- Width of sensor	35 mm
- Height of sensor	93.5 mm
- Length of sensor	30 mm

Diagram



Note Diagram

- positive break NC contact
- active
- no active
- Normally-open contact
- Normally-closed contact

Switch travel diagram

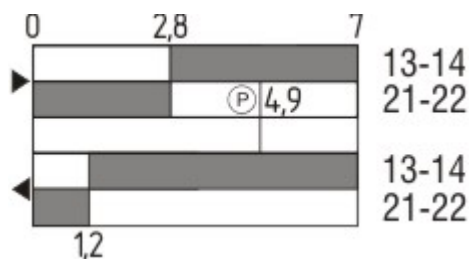

Notes Switch travel diagram

- Contact closed
- Contact open
- Setting range
- Break point
- Positive opening sequence/- angle
- VS** adjustable range of NO contact
- VÖ** adjustable range of NC contact
- N** after travel

Ordering suffix

The applicable ordering suffix is added at the end of the part number of the safety switch.

Order example: Z3K 235-11Z-**1637**

...-**1637** 0,3 µm gold-plated contacts

...-**NPT** Cable entry NPT 1/2"

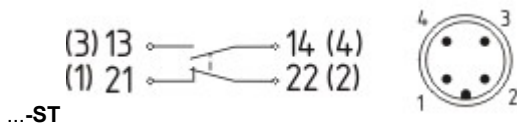

M12 connector with A-coding
 Rated impulse withstand voltage U_{imp} : 0,8 kV
 Rated insulation voltage U_i : 50 V
 Rated operating voltage U_e : 50 V
 Operating current I_e : 4 A
 Caution! The versions with connector may only be used in PELV circuits to EN 60204-1.

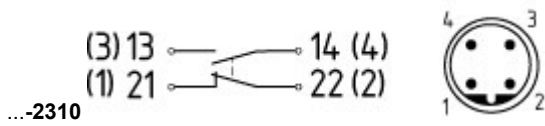

M12 connector with B-coding
 Rated impulse withstand voltage U_{imp} : 0,8 kV
 Rated insulation voltage U_i : 50 V
 Rated operating voltage U_e : 50 V
 Operating current I_e : 4 A
 Caution! The versions with connector may only be used in PELV circuits to EN 60204-1.

...-2574

\$missingName\$

Ordering code

(1)(2) 2(3)5-(4)Z(5)-(6)-(7)-(8)-(9)

(1)

Z

T

(2)

S

R

4S

4R

1R

K

3K

4K

K4

1H

7H

10H

12H

14H

AF

(3)

3

5

(4)

02

11

20

(5)

H

UE

(6)

without

ID

Snap action

Slow action

Plunger S

Roller plunger R

Plunger 4S

Roller plunger 4R

Offset roller lever 1R

Offset roller lever K

Angle roller lever 3K

Angle roller lever 4K

Angle roller lever K4

Roller lever 1H

Roller lever 7H

Rod lever 10H

Roller lever 12H

Roller lever 14H

Spring rod lever AF

slim design

large design

2 Opener (NC)

1 Normally open contact (NO) / 1 Opener (NC)

2 Normally open contact (NO), (Switch with 2 NO contacts are not for security tasks)

Slow action with staggered contacts

Slow action with overlapping contacts

Cable entry M20

IDC method of termination

NPT	cable entry NPT 1/2"
ST	M12 connector with A-coding (<i>Caution! The versions with connector may only be used in PELV circuits to EN 60204-1.</i>)
ST-2310	M12 connector with B-coding (<i>Caution! The versions with connector may only be used in PELV circuits to EN 60204-1.</i>)
(7)	
2574	
(8)	
2138	Roller lever 7H for Position switches with safety function
(9)	
1637	gold-plated contacts

Documents

Operating instructions and Declaration of conformity (en) 160 kB, 15.06.2018

Code: mrlk_zt235_236_en

Operating instructions and Declaration of conformity (es) 161 kB, 21.06.2018

Code: mrlk_ZT235_236_es

Operating instructions and Declaration of conformity (de) 160 kB, 15.06.2018

Code: mrlk_ZT235_236_de

Operating instructions and Declaration of conformity (pl) 198 kB, 27.06.2018

Code: mrlk_ZT235_236_pl

Operating instructions and Declaration of conformity (nl) 162 kB, 15.06.2018

Code: mrlk_ZT235_236_nl

Operating instructions and Declaration of conformity (pt) 163 kB, 27.06.2018

Code: mrlk_ZT235_236_pt

Operating instructions and Declaration of conformity (it) 162 kB, 15.06.2018

Code: mrlk_ZT235_236_it

Operating instructions and Declaration of conformity (fr) 164 kB, 15.06.2018

Code: mrlk_ZT235_236_fr

Operating instructions and Declaration of conformity (cs) 194 kB, 25.01.2019

Code: mrlk_ZT235_236_cs

Declaration of conformity (es) 91 kB, 18.06.2018

Code: KAS_konfi_nsr_zt2xx-3xx_es

Declaration of conformity (pl) 130 kB, 18.06.2018

Code: KAS_konfi_nsr_zt2xx-3xx_pl

Declaration of conformity (it) 89 kB, 18.06.2018

Code: KAS_konfi_nsr_zt2xx-3xx_it

Declaration of conformity (pt) 90 kB, 18.06.2018

Code: KAS_konfi_nsr_zt2xx-3xx_pt

Declaration of conformity (fr) 89 kB, 18.06.2018

Code: KAS_konfi_nsr_zt2xx-3xx_fr

Declaration of conformity (de) 581 kB, 07.06.2018

Code: KAS_konfi_nsr_zt2xx-3xx_de

Declaration of conformity (en) 579 kB, 07.06.2018

Code: KAS_konfi_nsr_zt2xx-3xx_en

Declaration of conformity (nl) 89 kB, 18.06.2018

Code: KAS_konfi_nsr_zt2xx-3xx_nl

CCC certification (cn) 4 MB, 11.04.2018

Code: q_235p02

CCC certification (en) 4 MB, 27.10.2017

Code: q_235p01

EAC certification (ru) 844 kB, 05.10.2015

Code: q_6037p17_ru

Images

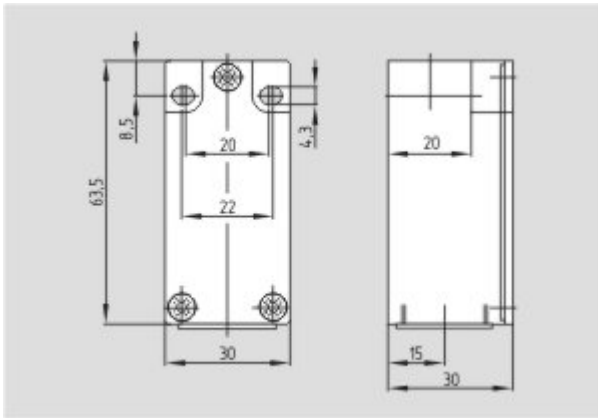

Dimensional drawing (basic component)

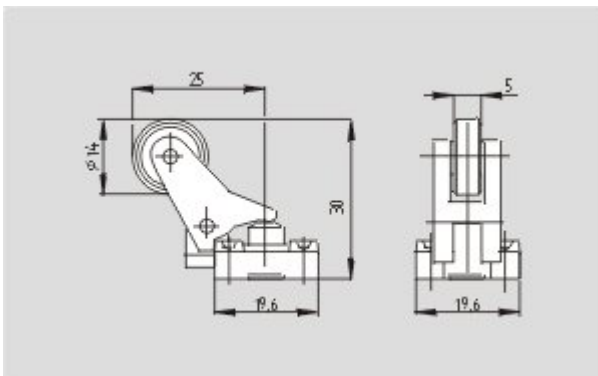

Dimensional drawing (actuator)

K.A. Schmersal GmbH & Co. KG, Möddinghofe 30, D-42279 Wuppertal

The data and values have been checked thoroughly. Technical modifications and errors excepted.

Generiert am 13.02.2019 - 13:13:52h Kasbase 3.3.0.F.64I