

Datasheet - T4VH 335 ST-AS

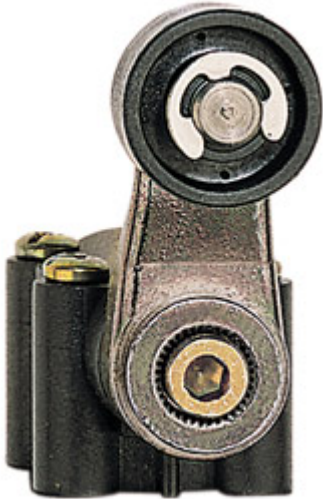

AS interface safety at work / Safety switchgear / Safety switches / 335 AS / AS - 335 Roller lever H



- AS-Interface M12 connector
- Metal enclosure
- Wide range of alternative actuators
- Good resistance to oil and petroleum spirit
- 40,5 mm x 96 mm x 38 mm
- Actuator heads can be repositioned by 4 x 90°
- Mounting details to EN 50047
- AS-Interface LED and status display
- Integrated AS-Interface
- Suitable for AS-i Power24

(Minor differences between the printed image and the original product may exist!)

Ordering details

Product type description	T4VH 335 ST-AS
Article number	T4VH 335 ST-AS
EAN Code	
eCl@ss	27-27-26-01

Approval

Approval



Classification

Standards	EN ISO 13849-1, IEC 61508
PL	up c
Control category	up 1
PFH	1.14 x 10 ⁻⁶ /
- notice	up to max. 100000 switching cycles/year
SIL	up 1
Mission time	20 Years

If a fault exclusion for hazardous damage of the 1-channel mechanics is authorized and an adequate protection against tampering is ensured, suitable for use up to:

Standards	EN ISO 13849-1, IEC 61508
PL	up d

Control category	up 3
PFH value	1.01 x 10 ⁻⁷ /
- notice	up to max. 100000 switching cycles/year
SIL	up 2
Mission time	20 Years

Global Properties

Permanent light	AS - 335 Rollenschwenkhebel H
Standards	EN 50295, EN 60947-5-1, EN ISO 13849-1, IEC 61508
Compliance with the Directives (Y/N) 	Yes
Suitable for safety functions (Y/N)	Yes
Actuator type	A to EN 50041
Materials	
- Material of the housings	Zink
- Lever material	Metal film
- Roller material	Plastic
- Material of the connector	Metal film
- Material of the contacts	Silver
Housing coating	painted
Housing construction form	Norm construction design
Weight	

Mechanical data

Design of actuating element	Roller lever
Design of electrical connection	connector plug M12, 5-pole, can be rotated
Mechanical life	1.000.000 operations
Switching frequency	5000
restistance to shock	30 / 11
Resistance to vibration	10 ... 150, Amplitude 0,35 / 5
Actuating speed with actuating angle 30° to switch axis	
- Min. Actuating speed	
- Max. Actuating speed	2.5

Ambient conditions

Ambient temperature	
- Min. environmental temperature	-25
- Max. environmental temperature	+60
- Min. Storage and transport temperature	-25
- Max. Storage and transport temperature	+85
Relative humidity	30 ... 95
- non-condensing	
- non-icing	
Protection class	IP67 to IEC/EN 60529

Electrical data

Design of control element	Opener (NC)
Switching principle	Creep circuit element
- positive break NC contact 	
Number of auxiliary contacts	0

Number of safety contacts	2
Rated impulse withstand voltage	800
Rated insulation voltage	32
Thermal test current	10 A
Utilisation category	AC-15: 230 V / 4 A, DC-13: 24 V / 1 A
Max. fuse rating	6 A gG D-fuse

Electrical data - AS interface

AS-i Supply voltage	18 ... 31.6 VDC, Protection against polarity reversal
AS-i operating current	≤ 50
AS-i Device insulation	internally short-circuit proof
AS-i Specification	
- version	V 3.0
- Profile	S-0.B.F.F
AS-i Inputs	
- Channel 1	Data bits DI 0/DI 1= dynamic code transmission
- Channel 2	Data bits DI 2/DI 3= dynamic code transmission
AS-i Outputs	DO 0 ... DO 3 not used
AS-i Parameter bits	P1 ... P3 not used
- P0	Channel 2 switched
AS-i input module address	0
- Default on address 0, programmable via the AS-Interface Master or Hand-held programming device	

LED switching conditions display

LED switching conditions display (Y/N)	Yes
AS-i LED switching conditions display	
(1) yellow LED	Channel 1 / AS-i SaW Bit 0,1
(2) green/red LED (AS-i duo LED)	Supply voltage / Communication error / slave address = 0
(3) yellow LED	Channel 2 / AS-i SaW Bit 2,3

ATEX

Explosion protection categories for gases	None
Explosion protected category for dusts	None

Dimensions

Dimensions of the sensor	
- Width of sensor	40.5
- Height of sensor	149.5
- Length of sensor	60.55
- Roller diameter	20

Pin assignment

1	AS interface +
2	None
3	AS interface -
4	None
5	Functional earth connection



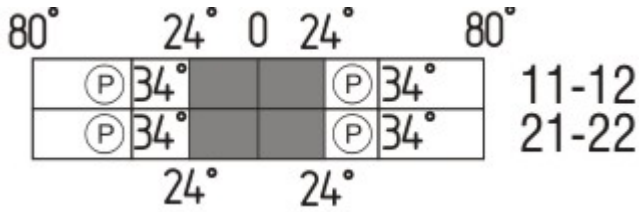

notice

The addressing must take place via the M12 connector or the flat cable connection.

Switch travel diagram



Notes Switch travel diagram

-  Contact closed
-  Contact open
-  Setting range
-  Break point
-  Positive opening sequence/- angle
- VS** adjustable range of NO contact
- VÖ** adjustable range of NC contact
- N** after travel

Ordering suffix

The applicable ordering suffix is added at the end of the part number of the safety switch.

Order example: T4VH 335 ST-AS-FK

...-FK

\$missingName\$

...-RMS

Available with metal roller

Ordering code

T(1) 335 (2)-AS

(1)

S	Plunger S
R	Roller plunger R
1K	Offset roller lever 1K
3K	Angle roller lever 3K
H	Roller lever H
1H	Roller lever 1H
7H	Roller lever 7H
(2)	
ST	connector plug M12, Metal film
FK	Connection for flat cable

Documents

Operating instructions and Declaration of conformity (en) 316 kB, 22.11.2017

Code: mrl_t335as_en

Operating instructions and Declaration of conformity (de) 610 kB, 01.02.2010

Code: mrl_t335as_de

TÜV certification (de, en) 46 kB, 02.04.2014

Code: z_t3p01

TÜV certification (de, en) 305 kB, 01.06.2010

Code: z_asip06

Images



Product photo

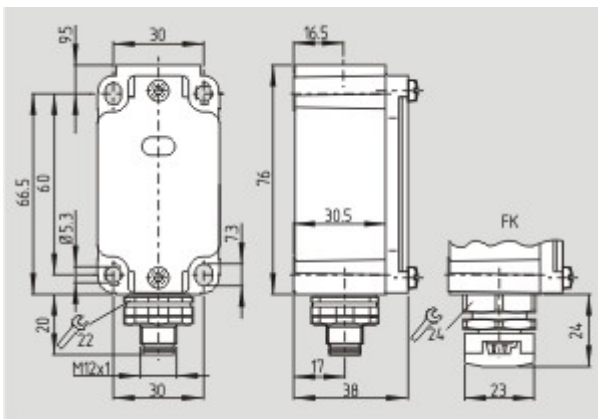

Dimensional drawing (basic component)

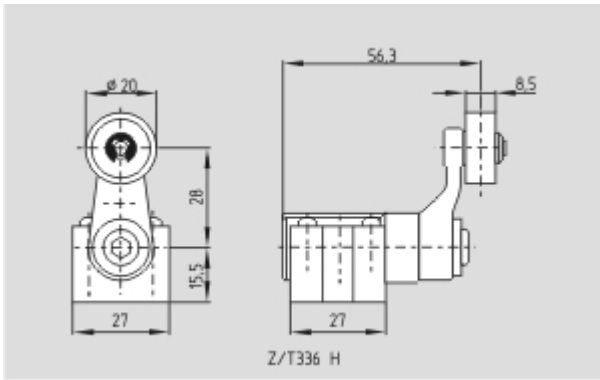

Dimensional drawing (actuator)

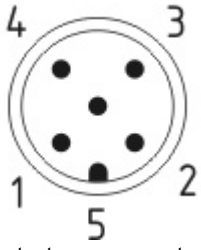

Contact arrangement



Operating principle
