

Datasheet - US 434Y-4S



Position switch / medium heavy Position switch / Universal range U - Metal enclosure / U 434 / U 434 Plunger S



- Metal enclosure
- 4 Contacts
- 62 mm x 127 mm x 50 mm (basic component)
- Switching points and contact function adjustable
- 3 cable entries M 20 x 1.5

(Minor differences between the printed image and the original product may exist!)

Ordering details

Product type description	US 434Y-4S
Article number	101093276
EAN Code	4030661267302
eCl@ss	27-27-06-01

Approval

Approval



Global Properties

Permanent light	U 434 Druckbolzen S
Standards	EN 60947-5-1
Compliance with the Directives (Y/N) 	Yes
Suitable for safety functions (Y/N)	No
Standard housing (Y/N)	No
Materials	
- Material of the housings	light alloy die-casting
- Material of the contacts	Silver
Housing coating	painted
Weight	440

Mechanical data

Design of electrical connection	Screw connection
Cable section	
- Min. Cable section	1.5
- Max. Cable section	2.5
AWG-Number	13
Active principle	mechanical
Mechanical life	10.000.000 operations
Contact life	2.000.000 operations, at 6 A / 400 V, $\cos \varphi = 0,4$
notice	All indications about the cable section are including the conductor ferrules.
Design of actuating element	Plunger
Contact opening	2 x 1.5
Actuating speed with vertical actuating angle to switch axis	
- Min. Actuating speed	1
- Max. Actuating speed	1
- Actuating angle	20

Ambient conditions

Ambient temperature	
- Min. environmental temperature	-20
- Max. environmental temperature	+60
Protection class	IP65 to IEC/EN 60529

Electrical data

Design of control element	Normally open contact (NO)
Switching principle	Creep circuit element
Number of shutters	4
Number of openers	0
Rated insulation voltage U_i	500 V
Thermal test current I_{the}	16 A
Max. fuse rating	16 A gG D-fuse

Dimensions

Dimensions of the sensor	
- Width of sensor	62
- Height of sensor	138
- Length of sensor	50
Slide diameter	6

notice

Type of contact and switching points can be factory set to order.

notice

Actuation from the side of the plunger should be avoided, since this reduces the mechanical life of the position switch.

Indication legend



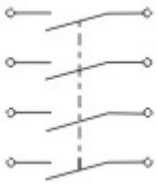

see drawing: Operating principle

Contact function, i. e. NC or NO contact, and switching points can be adjusted using a screwdriver

Diagram





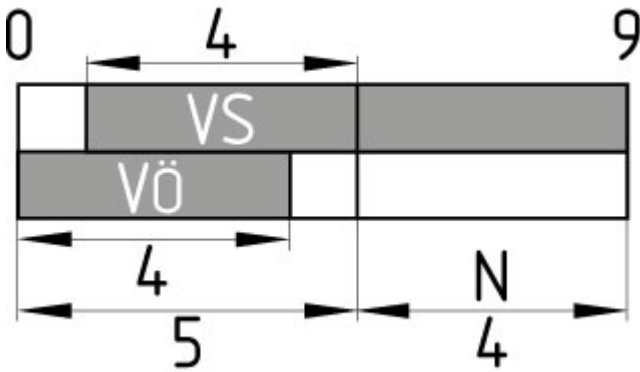

Note Diagram

-  positive break NC contact
-  active
-  no active
-  Normally-open contact
-  Normally-closed contact

Switch travel diagram



Notes Switch travel diagram

-  Contact closed
-  Contact open
-  Setting range
-  Break point
-  Positive opening sequence/- angle
- VS** adjustable range of NO contact
- VÖ** adjustable range of NC contact
- N** after travel

Ordering suffix

The applicable ordering suffix is added at the end of the part number of the safety switch.

Order example: US 434Y-4S- 1272

...- 1272

Version for low temperatures to -30°C

Ordering code

U(1) 434Y-(2)-(3)

(1)

S	Plunger S
K	Offset roller lever K
8H	Roller lever 8H
H	Roller lever H
3H	Roller lever 3H
7H	Roller lever 7H
4H	Spring rod lever on shaft 4H
9H	Rod lever 9H
10H	Rod lever 10H
2H	Leaf-spring lever 2H
6H	Leaf-spring lever 6H
(2)	
<i>without</i>	2 Normally open contact (NO) / 2 Opener (NC)
4OE	4 Opener (NC)
4S	4 Normally open contact (NO)
1S/3OE	1 Normally open contact (NO) / 3 Opener (NC)
3S/1OE	3 Normally open contact (NO) / 1 Opener (NC)
(3)	
1272	Version for low temperatures to -30°C

Documents

Operating instructions and Declaration of conformity (nl) 95 kB, 20.07.2018

Code: mrlk_posi-allgemein_nl

Operating instructions and Declaration of conformity (ru) 133 kB, 09.07.2018

Code: mrlk_posi-allgemein_ru

Operating instructions and Declaration of conformity (es) 88 kB, 09.07.2018

Code: mrlk_posi-allgemein_es

Operating instructions and Declaration of conformity (en) 86 kB, 09.07.2018

Code: mrlk_posi-allgemein_en

Operating instructions and Declaration of conformity (cn) 138 kB, 09.07.2018

Code: mrlk_posi-allgemein_cn

Operating instructions and Declaration of conformity (it) 86 kB, 09.07.2018

Code: mrlk_posi-allgemein_it

Operating instructions and Declaration of conformity (jp) 285 kB, 09.07.2018

Code: mrlk_posi-allgemein_jp

Operating instructions and Declaration of conformity (pl) 118 kB, 09.07.2018

Code: mrlk_posi-allgemein_pl

Operating instructions and Declaration of conformity (fr) 85 kB, 09.07.2018

Code: mrlk_posi-allgemein_fr

Operating instructions and Declaration of conformity (pt) 86 kB, 09.07.2018

Code: mrlk_posi-allgemein_pt

Operating instructions and Declaration of conformity (de) 88 kB, 09.07.2018

Code: mrlk_posi-allgemein_de

Operating instructions (pl) 369 kB, 30.11.2018

Code: mrlk_u431-u434_pl

Operating instructions (en) 352 kB, 06.08.2018

Code: mrlk_u431-u434_en

Operating instructions (es) 350 kB, 08.08.2018

Code: mrlk_u431-u434_es

Operating instructions (nl) 365 kB, 12.11.2018

Code: mrlk_u431-u434_nl

Mounting and wiring instructions (de, en, fr) 209 kB, 17.03.2008

Code: m_43sp01

Operating instructions (de) 348 kB, 06.08.2018

Code: mrlk_u431-u434_de

Operating instructions (pt) 350 kB, 23.08.2018

Code: mrlk_u431-u434_pt

Declaration of conformity (en) 158 kB, 07.11.2017

Code: konfi_mrl_u43_en

Declaration of conformity (de) 128 kB, 07.11.2017

Code: konfi_mrl_u43_de

EAC certification (ru) 388 kB, 20.01.2016

Code: q_1527p17_ru

Images

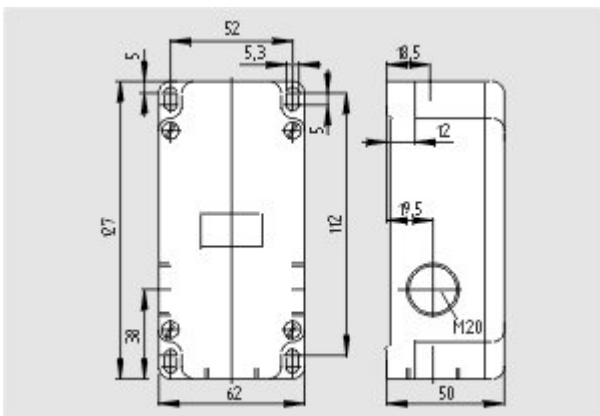

Dimensional drawing (basic component)

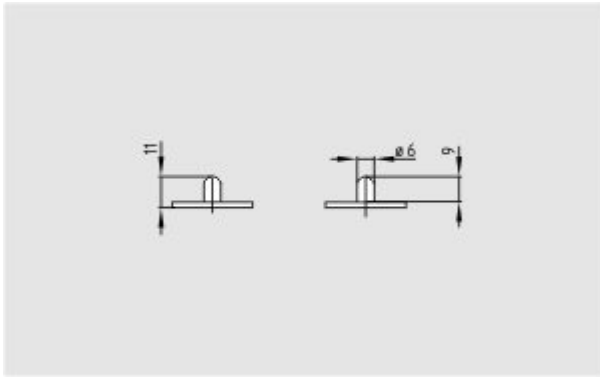

Dimensional drawing (miscellaneous)

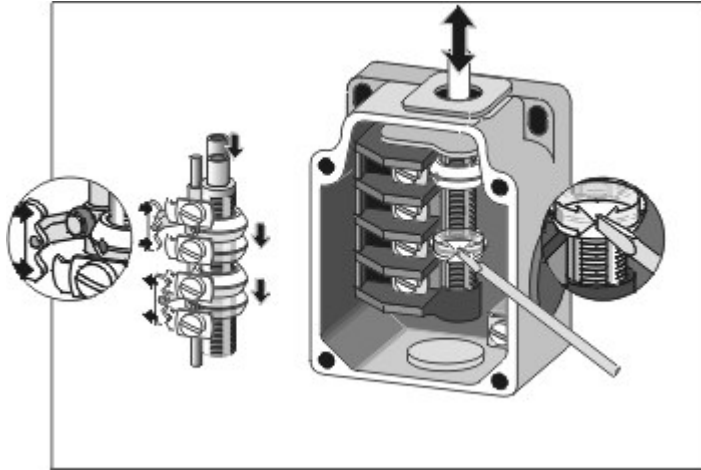

Operating principle



Operating principle