

## Datasheet - UV6H 434Y-4OE



Position switch / medium heavy Position switch / Universal range U - Metal enclosure / U 434 / U 434 Leaf-spring lever 6H



- Metal enclosure
- 4 Contacts
- 62 mm x 127 mm x 50 mm ( basic component)
- Switching points and contact function adjustable
- 3 cable entries M 20 x 1.5
- Actuator head can be repositioned in steps 4 x 90°
- Continuous adjustment of lever position 360°
- Lever can be transposed by 180°
- Spring-steel leaf spring

(Minor differences between the printed image and the original product may exist!)

### Ordering details

Product type description	UV6H 434Y-4OE
Article number	UV6H 434Y-4OE
EAN Code	
eCl@ss	27-27-06-01

### Approval

Approval



### Global Properties

Permanent light	U 434 Blattfederschwenkhebel 6H
Standards	EN 60947-5-1
Compliance with the Directives (Y/N) 	Yes
Suitable for safety functions (Y/N)	No
Standard housing (Y/N)	No
Materials	
- Material of the housings	light alloy die-casting
- Lever material	Spring-steel
- Material of the contacts	Silver
Housing coating	painted

Weight	610
Slide form	

## Mechanical data

---

Design of electrical connection	Screw connection
Cable section	
- Min. Cable section	1.5
- Max. Cable section	2.5
AWG-Number	13
Active principle	mechanical
Mechanical life	10.000.000 operations
Contact life	2.000.000 operations, at 6 A / 400 V, $\cos \varphi = 0,4$
notice	All indications about the cable section are including the conductor ferrules.
Design of actuating element	Swivel lever
Contact opening	2 x 1.5
Actuating speed with vertical actuating angle to switch axis	
- Min. Actuating speed	1
- Max. Actuating speed	3
- Actuating angle from left of switch axis	30
- Actuating angle from right of switch axis	30

## Ambient conditions

---

Ambient temperature	
- Min. environmental temperature	-20
- Max. environmental temperature	+60
Protection class	IP65 to IEC/EN 60529

## Electrical data

---

Design of control element	Opener (NC)
Switching principle	Creep circuit element
Number of shutters	0
Number of openers	4
Rated insulation voltage $U_i$	500 V
Thermal test current $I_{the}$	16 A
Max. fuse rating	16 A gG D-fuse

## Dimensions

---

Dimensions of the sensor	
- Width of sensor	62
- Height of sensor	456
- Length of sensor	50
Leaf spring thick	0,8

## notice

---

Type of contact and switching points can be factory set to order.

## Indication legend

---



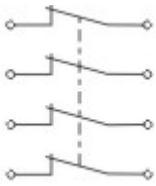

see drawing: Operating principle

Contact function, i. e. NC or NO contact, and switching points can be adjusted using a screwdriver

## Diagram





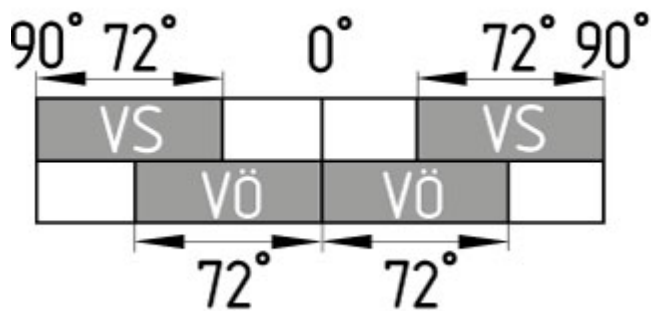

Note Diagram

-  positive break NC contact
-  active
-  no active
-  Normally-open contact
-  Normally-closed contact

## Switch travel diagram



Notes Switch travel diagram

-  Contact closed
-  Contact open
-  Setting range
-  Break point
-  Positive opening sequence/- angle
- VS** adjustable range of NO contact
- VÖ** adjustable range of NC contact
- N** after travel

## Ordering suffix

The applicable ordering suffix is added at the end of the part number of the safety switch.

Order example: UV6H 434Y-4OE- 1272

...- 1272

Version for low temperatures to -30°C

## Ordering code

U(1) 434Y-(2)-(3)

(1)

S

Plunger S

K

Offset roller lever K

8H	Roller lever 8H
H	Roller lever H
3H	Roller lever 3H
7H	Roller lever 7H
4H	Spring rod lever on shaft 4H
9H	Rod lever 9H
10H	Rod lever 10H
2H	Leaf-spring lever 2H
6H	Leaf-spring lever 6H
(2)	
<i>without</i>	2 Normally open contact (NO) / 2 Opener (NC)
4OE	4 Opener (NC)
4S	4 Normally open contact (NO)
1S/3OE	1 Normally open contact (NO) / 3 Opener (NC)
3S/1OE	3 Normally open contact (NO) / 1 Opener (NC)
(3)	
1272	Version for low temperatures to -30°C

## Documents

---

### Operating instructions and Declaration of conformity (nl) 95 kB, 20.07.2018

Code: mrlk\_posi-allgemein\_nl

### Operating instructions and Declaration of conformity (ru) 133 kB, 09.07.2018

Code: mrlk\_posi-allgemein\_ru

### Operating instructions and Declaration of conformity (es) 88 kB, 09.07.2018

Code: mrlk\_posi-allgemein\_es

### Operating instructions and Declaration of conformity (en) 86 kB, 09.07.2018

Code: mrlk\_posi-allgemein\_en

### Operating instructions and Declaration of conformity (cn) 138 kB, 09.07.2018

Code: mrlk\_posi-allgemein\_cn

### Operating instructions and Declaration of conformity (it) 86 kB, 09.07.2018

Code: mrlk\_posi-allgemein\_it

### Operating instructions and Declaration of conformity (jp) 285 kB, 09.07.2018

Code: mrlk\_posi-allgemein\_jp

### Operating instructions and Declaration of conformity (pl) 118 kB, 09.07.2018

Code: mrlk\_posi-allgemein\_pl

### Operating instructions and Declaration of conformity (fr) 85 kB, 09.07.2018

Code: mrlk\_posi-allgemein\_fr

### Operating instructions and Declaration of conformity (pt) 86 kB, 09.07.2018

Code: mrlk\_posi-allgemein\_pt

### Operating instructions and Declaration of conformity (de) 88 kB, 09.07.2018

Code: mrlk\_posi-allgemein\_de

### Operating instructions (pl) 369 kB, 30.11.2018

Code: mrlk\_u431-u434\_pl

**Operating instructions** (en) 352 kB, 06.08.2018

Code: mrlk\_u431-u434\_en

**Operating instructions** (es) 350 kB, 08.08.2018

Code: mrlk\_u431-u434\_es

**Operating instructions** (nl) 365 kB, 12.11.2018

Code: mrlk\_u431-u434\_nl

**Mounting and wiring instructions** (de, en, fr) 209 kB, 17.03.2008

Code: m\_43sp01

**Operating instructions** (de) 348 kB, 06.08.2018

Code: mrlk\_u431-u434\_de

**Operating instructions** (pt) 350 kB, 23.08.2018

Code: mrlk\_u431-u434\_pt

**Declaration of conformity** (en) 158 kB, 07.11.2017

Code: konfi\_mrl\_u43\_en

**Declaration of conformity** (de) 128 kB, 07.11.2017

Code: konfi\_mrl\_u43\_de

**EAC certification** (ru) 388 kB, 20.01.2016

Code: q\_1527p17\_ru

## Images

---

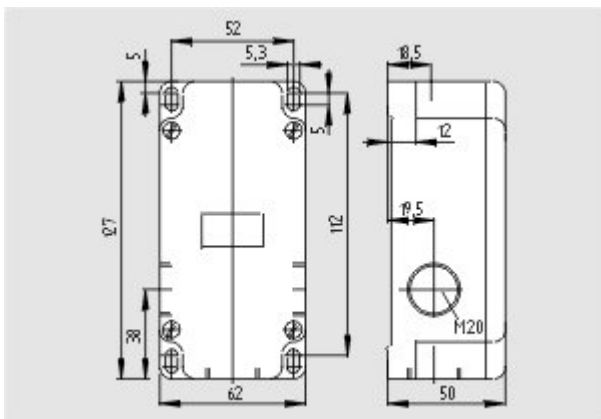

Dimensional drawing (basic component)

---

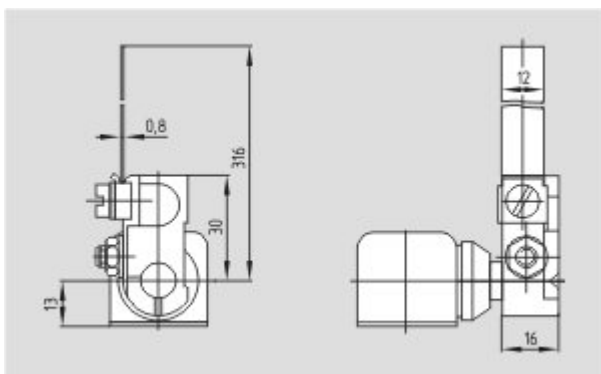

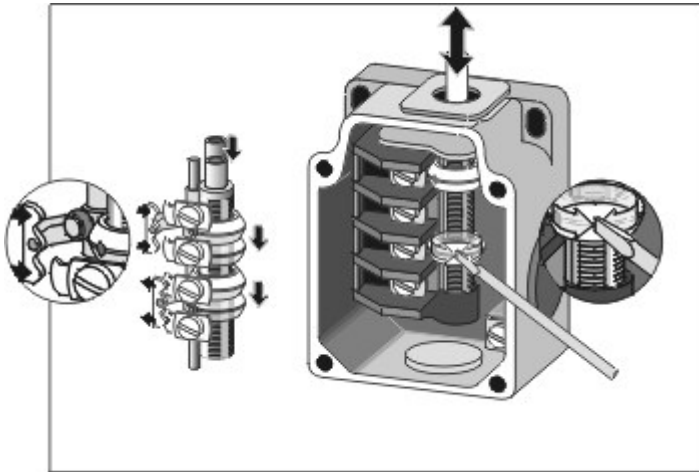

Operating principle

---

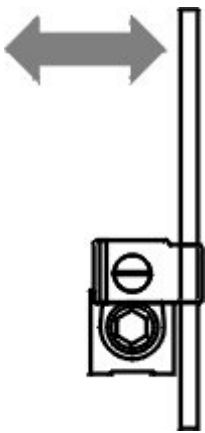

Operating principle

---